

BEDFORD[®]

SPRAY EQUIPMENT PARTS

Serving the
Spray Equipment
Industry for more
than 50 Years!

Paint Spray Parts & Equipment End-User Product Catalog September 1, 2019

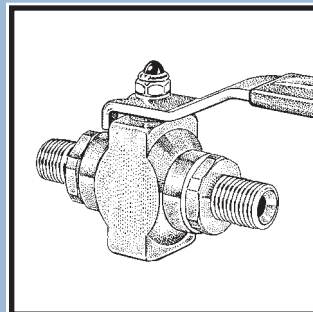
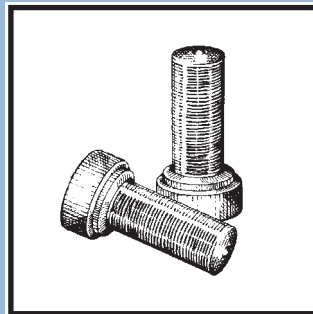
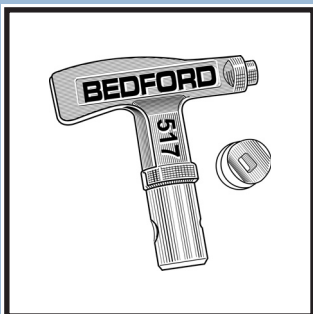
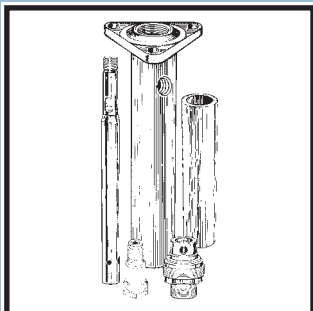
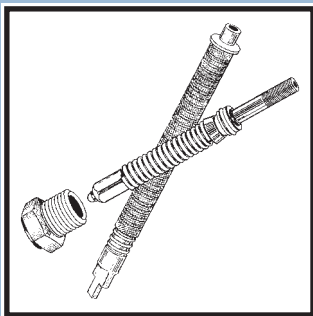
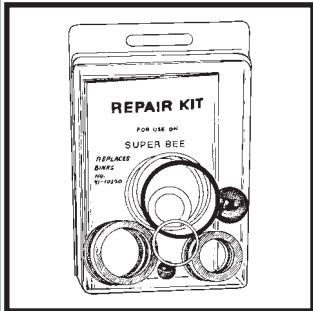

Parts and Components for:

- AIRLESSCO
- AMSPRAY
- ASM
- BINKS
- DEVILBISS
- GLIDDEN
- GRACO
- H.E.R.O.
- INT'L PUMP MFG (IPM)
- KREMLIN
- LARIUS
- SHARPE
- SHERWIN-WILLIAMS
- SPEEFLO
- TITAN
- WAGNER / SPRAYTECH

Your local Bedford dealer is:

ORDER FORM

DATE		PHONE		FAX	
PURCHASE ORDER NO.			ORDERED BY		
EMAIL ADDRESS					
COMPANY					
ADDRESS					
CITY, STATE ZIPCODE					
SHIP TO (If different)					
Additional shipping instructions:					
SHIP VIA:					
QUANTITY	PART NO.	DESCRIPTION	PRICE	AMOUNT	
Subtotal					
Total					

BEDFORD PRECISION PARTS LLC

To order, contact your local
Paint Spray Equipment Dealer and ask for
Genuine Bedford Replacement Parts.

BEDFORD® Replacement Parts For . . . AIRLESSCO Equipment

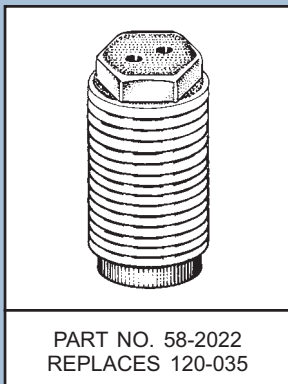
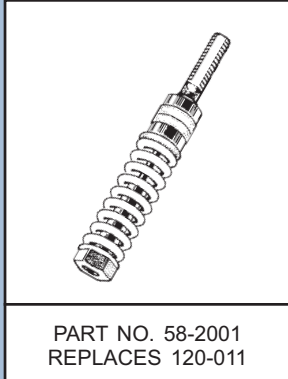

REPLACES AIRLESSCO PART NO.	BEDFORD PART NO.	DESCRIPTION
101-047	17-2238	Valve Label "OPEN-CLOSED"
106-005	15-3107	Teflon O-Ring
106-007	15-3070	Teflon O-Ring
106-009	15-1990	Teflon O-Ring
106-011	15-1998	Teflon O-Ring
106-012	15-1824	Teflon O-Ring
106-013	0-1825	O-Ring
106-014	0-1827	O-Ring
106-015	15-1832	Teflon O-Ring
106-016	0-1833	O-Ring
106-017	15-1834	Teflon O-Ring
106-018	15-1826	Teflon O-Ring
106-020	15-2052	Teflon O-Ring
106-021	15-2406	Teflon O-Ring
111-204	—	Order as: Graco 167-025 (14-185)
115-017	9-1818	Ball, 7/32", Carbide
115-022	9-1819	Ball, 5/16", Carbide
115-050	9-1820	Ball, 11/32", Carbide
120-007	58-2239	Carbide Ball Seat
120-008	8-2018	Tip Washer
120-011	58-2001	Valve Spring Unit - 007 Gun
120-012	12-2025	Guide
120-013	23-2026	Spring
120-014	44-2027	Shaft
120-021	19-2007	Locknut
120-032	18-2028	Male Adapter
120-033	2-2029	Seal, Teflon
120-034	18-2030	Female Adapter
120-035	58-2022	Diffuser/Valve Seat Assembly - 007 Gun
120-037	58-2024	Ball Holder Assembly - 007 Gun
141-008	14-1817	Inlet Strainer, 3/4" NPT Thread
141-010	14-1223	Inlet Strainer - 1" NPT (Stainless Steel Cap)
186-032	6-1821	Piston Seal
187-020	9-1822	Ball
187-022	17-1894	Ball Stop
187-027T	—	Replaced by 106-012 (15-1824)
187-027V	—	Replaced by 106-013 (0-1825)
187-028T	—	Replaced by 106-018 (15-1826)
187-028V	—	Replaced by 106-014 (0-1827)
187-029	49-2407	V-Packing
187-029L	—	Replaced by 187-059 (1-1828)
187-029T	2-1829	Teflon V-Packing
187-030	49-2408	V-Packing
187-030L	—	Replaced by 187-060 (1-1830)
187-030T	2-1831	Teflon V-Packing
187-033T	—	Replaced by 106-015 (15-1832)
187-033V	—	Replaced by 106-016 (0-1833)
187-034T	—	Replaced by 106-017 (15-1834)
187-037	18-2409	Male Adapter
187-040	20-1815	Kit - 3600, 4100, 5100, 5300, 6100 Pumps

BEDFORD® Replacement Parts For . . . AIRLESSCO Equipment

To order, contact your local
Paint Spray Equipment Dealer and ask for
Genuine Bedford Replacement Parts.

REPLACES AIRLESSCO PART NO.	BEDFORD PART NO.	DESCRIPTION
187-042	20-1947	Kit - 3600, 4100, 5100, 5300, 6100 Pumps
187-045	—	Replaced by 115-022 (9-1819)
187-058	18-2308	Female Gland
187-059	1-1828	Leather V-Packing
187-060	1-1830	Leather V-Packing
189-023P	18-1835	Female Adapter
189-028L	1-1836	Leather V-Packing
189-028T	2-1837	Teflon V-Packing
189-034T	15-1838	Teflon O-Ring
189-035T	15-1839	Teflon O-Ring
189-036T	15-1840	Teflon O-Ring
189-063	9-1841	Ball
189-376	20-1816	Kit - 8100, 9100 Pumps
331-014	18-1986	Male Adapter
331-015D	18-2277	Female Adapter, Double-Sided
331-016	49-1988	V-Packing
331-016L	1-1989	Leather V-Packing
331-020T	—	Replaced by 106-009 (15-1990)
331-020V	0-1991	O-Ring
331-021	18-1992	Female Adapter
331-022	18-1993	Male Adapter
331-023	49-1994	V-Packing
331-023L	1-1995	Leather V-Packing
331-026	58-2925	Outlet Seat - Power Pup, Little Pro
331-027	9-1996	Ball
331-030	9-1997	Ball
331-032T	—	Replaced by 106-011 (15-1998)
331-036T	—	Replaced by 106-020 (15-2052)
331-093	57-2930	Piston Rod Assembly - Little Pro, Power Pup
331-100	15-1985	Teflon O-Ring
331-105	0-2240	O-Ring
331-210	20-1999	Kit - Little Pro, Power Pup, 2400, 2500, 2600
331-211	20-2241	Kit - Prime & Pressure Relief Valve
331-217	14-3064	Inlet Filter, 3/4"-16 UNF(f)
331-217	—	Replaced by Graco 187-651
331-314	12-2926	Retainer
331-708	57-2928	Piston Rod - Little Pro, Power Pup
557-391	12-1483	Plug, 3/8" NPT
865-672	—	Replaced by 187-040 (20-1815)
867-214	14-185	Strainer, Manifold Filter - 60 Mesh (Long)
867-420	12-1482	Plug, 1/4" NPT with Hex Socket End
867-647	44-1305	Outlet Filter Support (aluminum)
KIT-1-007	55-2019	Tip Washers (12-pack)
KIT-2-007	20-2031	Ball Holder & Seal Kit - 007 Gun
KIT-3-007	20-2032	Kit - 007 Gun (Complete), Marathon Valve

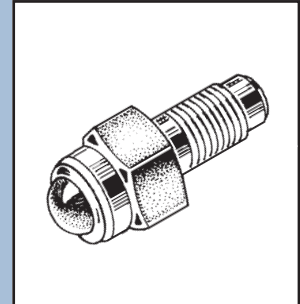

PART NO. 58-2024
REPLACES 120-037

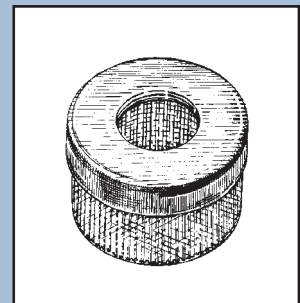

PART NO. 14-1817
REPLACES 141-008

To order, contact your local
Paint Spray Equipment Dealer and ask for
Genuine Bedford Replacement Parts.

BEDFORD® Replacement Parts For . . . BINKS Equipment

Quick Reference for . . . BINKS Spray Guns

SPRAY GUN	REPAIR KIT		PACKING KIT		PACKING KIT (10 PACK)	
	REPLACES BINKS PART NO.	BEDFORD PART NO.	REPLACES BINKS PART NO.	BEDFORD PART NO.	REPLACES BINKS PART NO.	BEDFORD PART NO.
MODEL 7	6-188	20-324	6-213	20-317	6-216	20-1065
MODEL 18	6-189	20-328	6-214	20-318	6-217	20-1066
MODEL 62	—	—	6-163	20-1019	6-169	20-321
MODEL 69	6-195	20-329	6-185	20-322	6-186	—
MODEL 95	54-3577	20-2154	54-4225	20-2080	—	—
MODEL 2001 / 2100	6-229	20-1175	6-231	20-1148	6-230	20-1147
MODEL 2001P	6-409	20-1501	—	—	—	—
MACH 1 / BBR	54-3605	20-1880	54-4225	20-2080	—	—
MACH 1A	54-3980	20-2340	—	—	—	—

Quick Reference for . . . BINKS Pumps

FLUID PUMP	For the Bedford Replacement Part, refer to the following Binks component part numbers:					
	PUMP REPAIR KIT	UPPER PACKING SET	LOWER PACKING SET	PISTON ROD	LOWER BALL SEAT	UPPER BALL SEAT
HUMDINGER	41-12815	41-12822	41-12823	41-12703	41-12795	41-2460
SUPER BEE	41-10320	41-10074	41-10079	—	41-10275	—
HORNET	41-9656	41-9614	41-9613	—	—	—
SUPER HORNET	41-9745	41-9788	41-9791	—	—	—
WASP	41-9656	41-9614	41-9613	—	—	—

NOTE: Binks part numbers that are packaged and sold as multi-packs (-K5, -K10, etc.) are listed in this catalog as the single piece component part numbers and priced as such. When ordering these parts, order by the individual piece part number in any quantity desired.

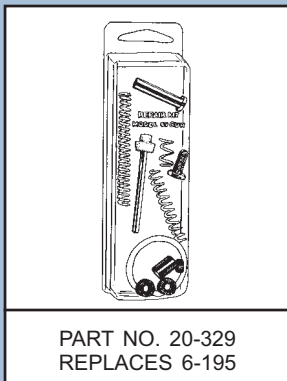

Replacement Parts for . . . BINKS

REPLACES BINKS PART NO.	BEDFORD PART NO.	DESCRIPTION
2-56	2-1842	Teflon Packing
6-163	20-1019	Packing Kit - #62 Gun
6-169	20-321	Packing Kits - #62 Gun (10-Pack)
6-185	20-322	Packing Kit - #69 Gun
6-188	20-324	Repair Kit - #7 Gun
6-189	20-328	Repair Kit - #18 Gun
6-195	20-329	Repair Kit - #69 Gun
6-213	20-317	Packing Kit - #7 Gun
6-214	20-318	Packing Kit - #18 Gun
6-216	20-1065	Packing Kits - #7 Gun (10-Pack)
6-217	20-1066	Packing Kits - #18 Gun (10-Pack)
6-229	20-1175	Repair Kit - #2001, #2100 Guns
6-230	20-1147	Packing Kits - #2001 Gun (10-Pack)
6-231	20-1148	Packing Kit - #2001 Gun
6-409	20-1501	Repair Kit - #2001P Gun

BEDFORD® Replacement Parts For . . . BINKS Equipment

To order, contact your local
Paint Spray Equipment Dealer and ask for
Genuine Bedford Replacement Parts.

REPLACES BINKS PART NO.	BEDFORD PART NO.	DESCRIPTION
20-1544	9-179	Ball
20-1592	12-1483	Plug, 3/8" NPT
20-2111	0-1720	O-Ring
20-2194	9-252	Ball
20-2198	0-335	O-Ring
20-2200	9-121	Ball
20-2227	0-1244	O-Ring
20-2288-1	12-1482	Plug, 1/4" NPT with Hex Socket End
20-2606-1	19-1663	Screw
20-2630	9-611	Ball
20-2631	9-177	Ball
20-3022	0-154	O-Ring
20-3023	0-685	O-Ring
20-3157	0-1359	O-Ring
20-3201	0-1716	O-Ring
20-3236	0-1503	O-Ring
20-3248	0-1715	O-Ring
20-3250	9-333	Ball
20-3276	0-1245	O-Ring
20-3515	0-1712	O-Ring
20-3562	15-1017	Teflon O-Ring
20-3599	15-1848	Teflon O-Ring
20-3620	0-2330	O-Ring
20-3757	0-1141	O-Ring
20-3847	0-1719	O-Ring
20-3859	0-1323	O-Ring
20-3955	9-1179	Ball
20-4067	12-407	Swivel Adapter 1/2" NPT(m) x 3/8" NPS(f)
20-4232	9-136	Ball
20-4256	12-251	Swivel Adapter 3/8" NPT(f) x 3/8" NPS(f)
20-4276	12-411	Swivel Adapter 1/2" NPT(f) x 3/8" NPS(f)
20-4277	12-412	Swivel Adapter 1/2" NPT(f) x 1/2" NPS(f)
20-4278	12-413	Swivel Adapter 3/4" NPT(f) x 3/4" NPS(f)
20-4281	12-405	Swivel Adapter 3/8" NPT(m) x 3/8" NPS(f)
20-4283	12-465	Swivel Adapter 1/2" NPT(m) x 1/2" NPS(f)
20-4429	0-956	O-Ring
20-4445	0-1714	O-Ring
20-4455	12-408	Swivel Adapter 3/4" NPT(m) x 3/4" NPS(f)
20-4468	12-403	Swivel Adapter 1/4" NPT(m) x 3/8" NPS(f)
20-4511	0-2276	O-Ring
20-4564	—	Functionally equivalent to 81-307 (12-971)
20-4615	15-1718	Teflon O-Ring
20-4728	0-419	O-Ring
20-4731	6-666	Backup Ring
20-4962	9-659	Ball
20-4963	9-615	Ball
20-5052	0-1713	O-Ring
20-5205	0-1381	O-Ring
20-5285	0-1142	O-Ring
20-5286	0-2339	O-Ring

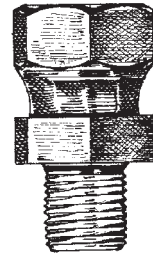

PART NO. 12-402
REPLACES 41-1412

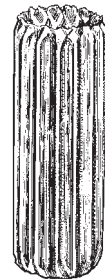

PART NO. 14-347
REPLACES 41-2629

To order, contact your local
Paint Spray Equipment Dealer and ask for
Genuine Bedford Replacement Parts.

BEDFORD® Replacement Parts For . . . BINKS Equipment

REPLACES BINKS PART NO.	BEDFORD PART NO.	DESCRIPTION
20-5430	9-137	Ball
20-5740	15-1717	Teflon O-Ring
20-6160	15-2153	Teflon O-Ring
20-6536	19-1956	Packing Removal Screw
41-1242	2-887	Teflon V-Packing
41-1295	10-595	Gasket
41-1346	1-1247	Leather V-Packing
41-1412	12-402	Swivel Adapter 1/4" NPT(m) x 1/4" NPS(f)
41-1434	2-199	Teflon V-Packing
41-1530	1-664	Leather V-Packing
41-1533	1-641	Leather V-Packing
41-1596	1-436	Leather V-Packing
41-1597	1-513	Leather V-Packing
41-1670	2-168	Teflon V-Packing
41-1671	2-169	Teflon V-Packing
41-1691	1-530	Leather V-Packing
41-1692	1-1262	Leather V-Packing
41-1700	1-910	Leather V-Packing
41-1804	10-646	Seal
41-1898	1-642	Leather V-Packing
41-2075	2-170	Teflon V-Packing
41-2277	2-337	Teflon V-Packing
41-2421	2-338	Teflon V-Packing
41-2422	4-1392	Teflon Cup
41-2442	10-645	Gasket
41-2457	2-198	Teflon V-Packing
41-2460	58-1891	Upper Ball Seat - Humdinger
41-2627	14-345	Filter Element - .006 Screen (100 Mesh)
41-2628	—	Replaced by 41-2629 (14-347) 50 Mesh
41-2629	14-347	Filter Element - .012 Screen (50 Mesh)
41-2739	20-644	Packing Kit - Economy
41-2828	2-336	Teflon V-Packing
41-2854	1-665	Leather V-Packing
41-9613	20-1280	Lower Packing Set - Hornet / Wasp
41-9614	20-1281	Upper Packing Set - Hornet / Wasp
41-9617	10-948	Seal
41-9628	18-945	Male Adapter
41-9630	18-943	Female Adapter
41-9631	1-908	Leather V-Packing
41-9632	2-884	Teflon V-Packing
41-9633	18-944	Male Adapter
41-9634	18-946	Female Adapter
41-9635	1-909	Leather V-Packing
41-9636	2-885	Teflon V-Packing
41-9639	6-950	Tube Seal
41-9646	6-949	Valve Seal
41-9656	20-952	Kit - Hornet / Wasp
41-9695	6-1352	Seal
41-9712	10-332	Gasket
41-9718	10-947	Gasket

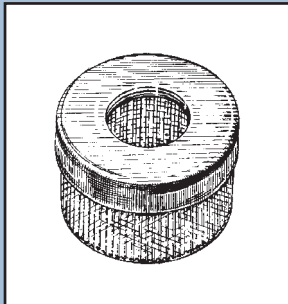

PART NO. 14-674
REPLACES 41-10094

BEDFORD® Replacement Parts For . . . BINKS Equipment

To order, contact your local
Paint Spray Equipment Dealer and ask for
Genuine Bedford Replacement Parts.

REPLACES BINKS PART NO.	BEDFORD PART NO.	DESCRIPTION
41-9728	18-1128	Male Adapter
41-9729	18-1129	Female Adapter
41-9731	6-1127	Tube Seal
41-9736	18-1130	Female Adapter
41-9737	1-911	Leather V-Packing
41-9738	2-886	Teflon V-Packing
41-9739	18-1131	Male Adapter
41-9745	20-1132	Kit - Super Hornet
41-9788	20-1432	Upper Packing Set - Super Hornet
41-9791	20-1433	Lower Packing Set - Super Hornet
41-10069	6-334	Gasket
41-10074	20-376	Upper Packing Set - Super Bee
41-10075	18-661	Female Adapter
41-10076	18-660	Male Adapter
41-10079	20-377	Lower Packing Set - Super Bee
41-10080	18-663	Female Adapter
41-10083	18-662	Male Adapter
41-10090	10-593	Gasket
41-10094	14-674	Inlet Strainer - 3/4" NPT Thread
41-10149	8-1108	Gasket
41-10275	58-1892	Lower Ball Seat - Super Bee
41-10285	20-639	Packing Set - "B"
41-10320	20-375	Kit - Super Bee
41-12669	1-214	Leather V-Packing
41-12703	57-1462	Rod - Humdinger
41-12711	18-326	Male Adapter
41-12715	18-532	Male Adapter
41-12718	8-1070	Gasket
41-12720	8-1069	Gasket
41-12722	8-1067	Gasket
41-12795	58-1893	Lower Ball Seat - Humdinger
41-12815	20-1092	Kit - Humdinger
41-12818	18-210	Female Adapter
41-12819	18-213	Female Adapter
41-12820	2-220	Teflon V-Packing
41-12821	2-531	Teflon V-Packing
41-12822	20-533	Upper Packing Set - Humdinger
41-12823	20-566	Lower Packing Set - Humdinger
54-304	23-777	Spring
54-722	7-1052	Wiper Cup
54-723	10-745	Gasket
54-728	23-775	Spring
54-736	23-779	Spring
54-738	7-778	Packing
54-739	8-182	Gasket
54-744	47-363	Stem
54-747	7-755	Packing
54-749	8-951	Gasket
54-750	23-773	Spring
54-759	44-176	Screw
54-760	44-178	Stud
54-764	10-764	Packing, graphite
54-918	8-701	Gasket
54-1014	44-1045	Pin
54-1020	44-215	Stud

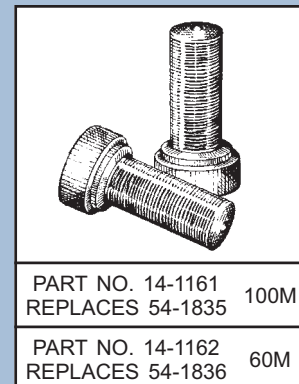

To order, contact your local
Paint Spray Equipment Dealer and ask for
Genuine Bedford Replacement Parts.

BEDFORD® Replacement Parts For . . . BINKS Equipment

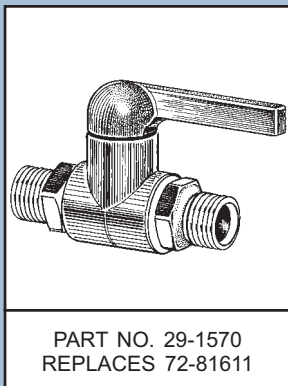
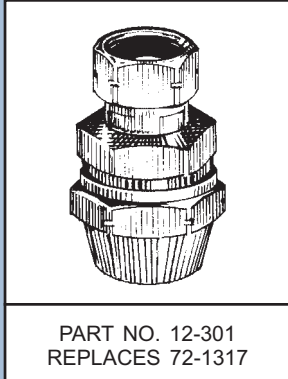

REPLACES BINKS PART NO.	BEDFORD PART NO.	DESCRIPTION
54-1025	47-364	Stem
54-1347	23-248	Spring
54-1439	8-830	Gasket
54-1697	23-1043	Spring
54-1734	44-1046	Pin
54-1735	7-1018	Packing
54-1835	14-1161	Tip Filter, 100 Mesh, Fine
54-1836	14-1162	Tip Filter, 60 Mesh, Coarse
54-2066	7-757	Packing
54-2229	8-649	Gasket
54-3512	47-1877	Spindle Assembly - Mach I / BBR
54-3518	23-1878	Spring, Blue
54-3520	23-1879	Spring, Yellow
54-3577	20-2154	Kit - Model 95 Gun
54-3605	20-1880	Kit - Mach I / BBR Gun
54-3710	10-1845	Packing Gland
54-3729	6-2331	Seal
54-3919	—	Order as: (1) 54-1020 & (1) 82-126
54-3980	20-2340	Kit - BBR & Mach 1A Automatic Guns
54-4225	20-2080	Kit - #95 Gun Fluid Inlet
54-4226	20-2155	Spindle Kit - Model 95 Gun
54-4261	20-1960	Needle Packing Kit - Mach I / BBR
54-4263	12-1959	Packing Nut
54-4264	4-1954	Adapter
54-4265	4-1955	Needle Seal
54-4266	10-1957	Seal, Backup
54-4267	23-1958	Spring
56-730	54-32	Cup Lid Gasket
58-266	44-174	Stud, Trigger
71-28	12-227	Brass Nipple 1/8" NPT x 1/4" NPS
71-130	13-64	1/4" Red Smooth Air Hose, Cut Length
71-131	13-79	5/16" Red Smooth Air Hose, Cut Length
71-132	13-66	3/8" Red Air Hose, Cut Length
71-280	13-470	1/4" Fluid Hose, Full Reel (per foot)
71-282	13-480	3/8" Fluid Hose, Full Reel (per foot)
71-283	13-1010	1/2" Fluid Hose, Full Reel (per foot)
71-1103	13-520	15' x 1/4" Air Hose Assembly
71-1105	13-521	25' x 1/4" Air Hose Assembly
71-1106	13-522	50' x 1/4" Air Hose Assembly
71-1107	13-523	75' x 1/4" Air Hose Assembly
71-1108	13-524	100' x 1/4" Air Hose Assembly
71-1203	13-366	15' x 5/16" Air Hose Assembly
71-1205	13-354	25' x 5/16" Air Hose Assembly
71-1206	13-355	50' x 5/16" Air Hose Assembly
71-1207	13-356	75' x 5/16" Air Hose Assembly
71-1208	13-357	100' x 5/16" Air Hose Assembly
71-1303	13-529	15' x 3/8" Air Hose Assembly
71-1305	—	Replaced by 71-1355 (13-525)
71-1306	—	Replaced by 71-1356 (13-526)
71-1307	13-527	75' x 3/8" Air Hose Assembly
71-1308	13-528	100' x 3/8" Air Hose Assembly
71-1355	13-525	25' x 3/8" Air Hose Assembly
71-1356	13-526	50' x 3/8" Air Hose Assembly
71-280*	13-1170	1/4" Fluid Hose, Cut Length, 750 PSI
71-282*	13-1180	3/8" Fluid Hose, Cut Length, 750 PSI

BEDFORD® Replacement Parts For . . . BINKS Equipment

To order, contact your local
Paint Spray Equipment Dealer and ask for
Genuine Bedford Replacement Parts.

REPLACES BINKS PART NO.	BEDFORD PART NO.	DESCRIPTION
71-283*	13-1110	1/2" Fluid Hose, Cut Length, 750 PSI
71-284*	13-1190	3/4" Fluid Hose, Cut Length, 750 PSI
71-3302	13-485	15' x 3/8" Fluid Hose Assembly
71-3303	13-481	25' x 3/8" Fluid Hose Assembly
71-3304	13-482	50' x 3/8" Fluid Hose Assembly
71-3305	13-483	75' x 3/8" Fluid Hose Assembly
71-3306	13-484	100' x 3/8" Fluid Hose Assembly
71-3322	13-1015	15' x 1/2" Fluid Hose Assembly
71-3323	13-1011	25' x 1/2" Fluid Hose Assembly
71-3324	13-1012	50' x 1/2" Fluid Hose Assembly
71-3325	13-1013	75' x 1/2" Fluid Hose Assembly
71-3326	13-1014	100' x 1/2" Fluid Hose Assembly
71-3382	13-475	15' x 1/4" Fluid Hose Assembly
71-3383	13-471	25' x 1/4" Fluid Hose Assembly
71-3384	13-472	50' x 1/4" Fluid Hose Assembly
71-3385	13-473	75' x 1/4" Fluid Hose Assembly
71-3386	13-474	100' x 1/4" Fluid Hose Assembly
71-7704	13-931	25' x 1/4" Airless Hose Assembly
71-7705	13-932	50' x 1/4" Airless Hose Assembly
71-8085	13-798	5' x 3/16" Airless Hose Assembly
71-8086	13-794	10' x 3/16" Airless Hose Assembly
71-8087	13-795	15' x 3/16" Airless Hose Assembly
71-8088	13-796	25' x 3/16" Airless Hose Assembly
71-8089	13-797	50' x 3/16" Airless Hose Assembly
71-8424	13-451	25' x 3/8" Airless Hose Assembly
71-8425	13-453	50' x 3/8" Airless Hose Assembly
71-9130	—	Replaced by 71-10000 (13-4)
71-9131	—	Replaced by 71-11000 (13-59)
71-9132	—	Replaced by 71-12000 (13-6)
71-9280	—	Replaced by 71-280 (13-470)
71-9282	—	Replaced by 71-282 (13-480)
71-9283	—	Replaced by 71-283 (13-1010)
71-9284	—	Replaced by 71-284 (13-490)
71-10000	13-4	1/4" Red Air Hose, Full Reel (per foot)
71-11000	13-59	5/16" Red Smooth Air Hose, Full Reel (per ft)
71-12000	13-6	3/8" Red Smooth Air Hose, Full Reel (per ft)
72-55	12-599	Adapter 1/4" NPS(m) x 3/8" NPS(f)
72-918	12-201	Swivel Adapter 1/4" NPT(f) x 1/4" NPS(f)
72-945	12-406	Swivel Adapter 3/8" NPT(m) x 1/2" NPS(f)
72-995	12-229	Nipple 1/4" NPT x 3/8" NPT
72-1303	12-304	1/4" Hose Fitting x 1/4" NPS(f)
72-1306	12-306	1/4" Hose Fitting x 3/8" NPS(f)
72-1317	12-301	5/16" Hose Fitting x 1/4" NPS(f)
72-1325	12-303	3/8" Hose Fitting x 1/4" NPS(f)
72-1328	12-302	3/8" Hose Fitting x 3/8" NPS(f)
72-1333	12-368	1/2" Hose Fitting x 3/8" NPS(f)
72-1478	12-305	5/16" Hose Fitting x 1/4" NPT(m)
72-81212	29-2375	Ball Valve, 3/8" NPT x 3/8" NPT, 250 PSI
72-81216	29-1693	Ball Valve, 3/8" NPT x 1/4" NPS, 250 PSI
72-81611	29-1570	Ball Valve, 1/4" NPS x 1/4" NPT, 250 PSI
72-81612	29-1672	Ball Valve, 1/4" NPS x 3/8" NPT, 250 PSI
72-81711	29-1694	Ball Valve, 3/8" NPS x 1/4" NPT, 250 PSI
72-81712	29-1571	Ball Valve, 3/8" NPS x 3/8" NPT, 250 PSI
72-83030	29-2575	Ball Valve, 1/4" NPT x 1/4" NPT, 250 PSI
72-84030	29-2601	Ball Valve, 1/4" NPT x 3/8" NPT, 250 PSI

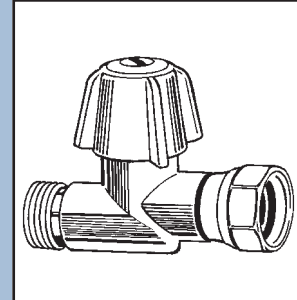

PART NO. 29-1680
REPLACES 73-157

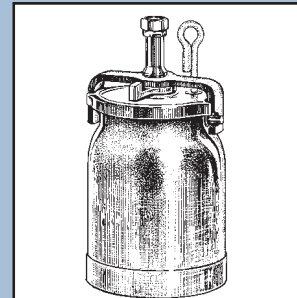

PART NO. 45-1235
REPLACES 81-350

To order, contact your local
Paint Spray Equipment Dealer and ask for
Genuine Bedford Replacement Parts.

BEDFORD® Replacement Parts For . . . BINKS Equipment

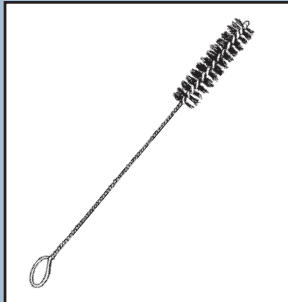

PART NO. 53-1101 9/16"
REPLACES 82-469 DIA

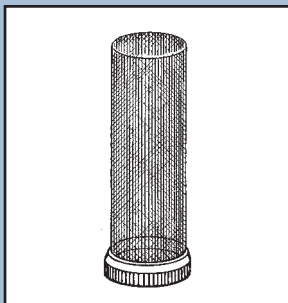

PART NO. 14-1734
REPLACES 83-1256

REPLACES BINKS PART NO.	BEDFORD PART NO.	DESCRIPTION
72-84040 73-9 73-42 73-43 73-44	29-2576 7-1384 47-1664 44-1665 12-1666	Ball Valve, 3/8" NPT x 3/8" NPT, 250 PSI Gasket Body Assembly Stem Nut
73-157 80-11 80-45 81-304 81-307	29-1680 54-81 54-45 13-918 12-971	Metering ("Cheater") Valve Cup Lid Gasket, White Plastic Cup Gasket, Leather Tube Connector, Nylon
81-350 81-352 81-354 81-355 81-357	45-1235 47-1232 46-1228 46-1229 17-1231	Cup Assembly - Non-Drip Centerpost Lever Cover Yoke
81-550 81-552 82-47 82-55 82-56	45-1255 44-1227 45-899 44-912 54-55	Cup Assembly - Standard Vent Quart Cup Nut 1-Quart Cup Lid Gasket, White Foam
82-126 82-158 82-368 82-467 82-469	44-175 7-749 8-1226 54-7 53-1101	Screw Packing Washer, Nylon Gasket Round Brush, 9/16"
83-576 83-1050 83-1256 83-1294 83-1419	12-222 12-221 14-1734 12-223 56-90	Brass Nipple 1/4" NPS x 1/4" NPT Brass Nipple 1/4" NPS x 1/4" NPS Filter Element, 100 Mesh Brass Nipple 3/8" NPS x 3/8" NPS Tank Lid Gasket, 2 Gallon, Stratoprene
83-1420 83-1421 83-1876 83-1879 83-1935	56-91 56-92 29-1676 29-941 12-409	Tank Lid Gasket, 5 Gallon, Stratoprene Tank Lid Gasket, 10 & 15 Gallon, Stratoprene ASME Air Relief Safety Valve - 80 PSI Air Safety Valve - 110 PSI Swivel Adapter 1/4" NPT(f) x 1/4" NPS(f)
83-2089 83-2405 83-2429 83-2596 83-2600	14-1732 14-1735 29-1677 14-1733 6-982	Filter Element, 50 Mesh Filter Element, 150 Mesh ASME Air Relief Safety Valve - 80 PSI Filter Element, 80 Mesh Teflon Seal
83-2621 83-2622 83-2623 83-2635 83-2705	20-1601 20-1602 20-1603 20-1604 14-1731	1/4" NPS(m) Fitting for Ball Valve 3/8" NPS(m) Fitting for Ball Valve 1/4" NPT(m) Fitting for Ball Valve 3/8" NPT(m) Fitting for Ball Valve Filter Element, 30 Mesh
83-2706 83-2727 85-70 86-558 101-1147	14-1736 28-759 28-1358 12-1481 10-1390	Filter Element, 200 Mesh Gauge, 0-100 PSI (Functionally equal) Gauge, 1/8" NPT Btm Mnt, 0-60 PSI, 1-1/2" Plug, 1/4" NPT Washer
101-6509 KB-4006	2-1016 —	Teflon V-Packing Order 6'x1/4 Fluid & 6'x5/16 Air Hose Assy's

BEDFORD® Replacement Parts For . . . DEVILBISS Equipment

To order, contact your local
Paint Spray Equipment Dealer and ask for
Genuine Bedford Replacement Parts.

REPLACES DEVILBISS PART NO.	BEDFORD PART NO.	DESCRIPTION
23165-001	6-1149	Teflon Gasket
42884-214-K5	55-1176	Cleaning Brushes, 3/8" Dia (Kit of 5)
42884-215-K10	55-1177	Cleaning Brushes, 5/8" Dia (Kit of 10)
A-23-K10	55-1906	Packings (Kit of 10)
A-42-K5	55-367	Screws (Kit of 5)
AD-31	12-221	Brass Nipple 1/4" NPS x 1/4" NPS
AD-404	12-599	Adapter 1/4" NPS(m) x 3/8" NPS(f)
AV-1-K5	55-1048	Gaskets (Kit of 5)
C-39-K5	55-71	Cup Gaskets (Kit of 5)
CV-5-K5	55-1055	Gaskets (Kit of 5)
GA-92	28-1358	Gauge, 1/8" NPT Btm Mnt, 0-60 PSI, 1-1/2"
GA-100	—	Functionally Equivalent to GA-333 Gauge
GA-211	28-719	Gauge, 1/4" NPT Btm Mnt, 0-200 PSI, 2"
GA-288	28-766	Gauge, 1/4" NPT Btm Mnt, 0-160 PSI, 2"
GA-316	28-705	Gauge, 1/4" NPT Rear Mnt, 0-160 PSI, 2"
GA-333	28-759	Gauge, 1/4" NPT Btm Mnt, 0-100 PSI, 2"
H-77	12-879	Brass Nipple 3/8" NPS x 5/8"-18
H-153	12-878	Brass Nipple 1/4" NPS x 5/8"-18
H-1446	12-223	Brass Nipple 3/8" NPS x 3/8" NPS
H-1766	12-227	Brass Nipple 1/8" NPT x 1/4" NPS
H-1901	13-57	5/16" Red Corrugated Air Hose (Reel) per foot
H-1921	13-59	5/16" Red Smooth Air Hose (Reel) per foot
H-1957	13-4	1/4" Red Air Hose (Reel) per foot
H-1958	13-6	3/8" Red Smooth Air Hose (Reel) per foot
H-1973-1	13-480	3/8" Fluid Hose (Reel) per foot
H-1974-1	13-1010	1/2" Fluid Hose (Reel) per foot
H-1975-1	13-470	1/4" Fluid Hose (Reel) per foot
H-2008	12-222	Brass Nipple 1/4" NPS x 1/4" NPT
H-4326	12-413	Swivel Adapter 3/8" NPT(f) x 3/8" NPS(f)
HA-0125	13-358	25' x 5/16" Air Hose Assembly (Corrugated)
HA-0150	13-359	50' x 5/16" Air Hose Assembly (Corrugated)
HA-2125	13-354	25' x 5/16" Air Hose Assembly (Smooth)
HA-2150	13-355	50' x 5/16" Air Hose Assembly (Smooth)
HA-7325	13-481	25' x 3/8" Fluid Hose Assembly
HA-7350	13-482	50' x 3/8" Fluid Hose Assembly
HA-7525	13-471	25' x 1/4" Fluid Hose Assembly
HAR-502	26-2328	Regulator, 1/4" for Series Installations
HAR-505	26-1125	Regulator, 1/4" General Purpose
HAR-555	26-1119	Regulator, 3/8" x 1/2" for Series Installations
HAV-500	29-1680	Functionally Equivalent to Binks 73-157
JGA-7-K5	—	Replaced by JGA-4035-K5 (55-2355)
JGA-14-K25	55-2350	Snap Rings (Kit of 25)
JGA-15-K25	55-2354	Washers (Kit of 25)
JGA-35-K5	55-1098	Trigger Bearing Studs (Kit of 5)
JGA-4035-K5	55-2355	Valve Packings (Kit of 5 Sets)
JGD-14-K10	55-1908	Gaskets (Kit of 10)
JGHV-116-K5	55-1963	Gaskets (Kit of 5)
JGS-26-K5	55-1139	U-Cups (Kit of 5)
JGS-35	—	See JGS-478 Kit (20-2268)
JGS-72-K10	55-913	Gaskets (Kit of 10)
JGS-431-K25	55-2356	Air Valve Assembly (Kit of 25)
JGS-449-1	20-1786	Air Valve Assembly
JGS-478	20-2268	Kit - (3) Trigger Studs & (5) Screws
KK-4058-1	20-1146	Kit - MBC Spray Gun
KK-4059	—	Replaced by KK-4987-2 (20-2055)

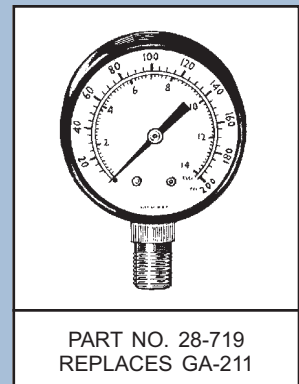
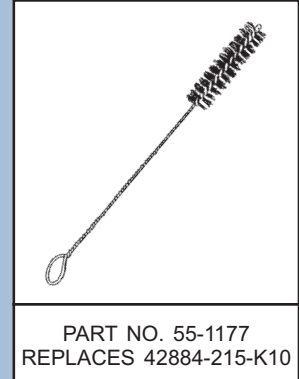

To order, contact your local
Paint Spray Equipment Dealer and ask for
Genuine Bedford Replacement Parts.

BEDFORD® Replacement Parts For . . . DEVILBISS Equipment

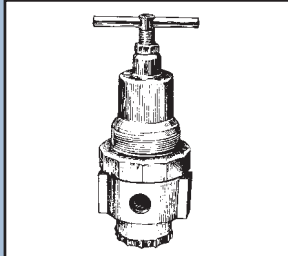

PART NO. 26-2328
REPLACES HAR-502

PART NO. 26-1125
REPLACES HAR-505

PART NO. 26-1119
REPLACES HAR-555

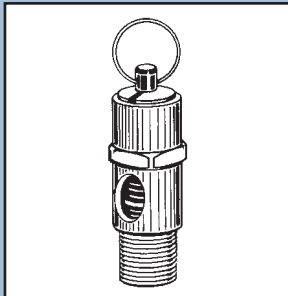

PART NO. 29-941
REPLACES TIA-5110

REPLACES DEVILBISS PART NO.	BEDFORD PART NO.	DESCRIPTION
KK-4138	24-1024	T-Handle & Cage - Gen'l Purpose Regulator
KK-4139	—	Functionally equivalent to KK-4167
KK-4167	24-1126	Repair Kit for General Purpose Regulators
KK-4830	—	Replaced by KK-4987-2 (20-2055)
KK-4911	20-1596	Kit - JGHV HVLP Spray Gun
KK-4987-2	20-2055	Kit - JGA, JGV, JGP, JGPV, MSA, MSV
KR-11-K5	55-74	Cup Gaskets (Kit of 5)
MB-16	44-1091	Stud, Trigger Bearing
MB-26-K5	55-1134	Packings (Kit of 5)
MB-135-K9	55-1159	Needle Valve Packings (Kit of 9)
MBC-28-K5	55-902	Springs (Kit of 5)
MBC-29	23-1156	Spring
MBC-62	3-1102	Packing
MBC-70-K2	55-1136	Needle Springs (Kit of 2)
MBC-1226	10-1068	Gasket
MBC-1226-K10	55-1097	Gaskets (Kit of 10)
MBD-12-K25	55-2357	Springs (Kit of 25)
MBD-14-K10	55-1152	Packing Washers (Kit of 10)
MBD-19-K10	55-1909	Springs (Kit of 10)
MBD-25-K5	55-1172	Springs (Kit of 5)
MSV-3-K10	55-2259	Fluid Inlet Gaskets (Kit of 10)
P-H-5516	—	Functionally Equivalent to Binks 73-157 Valve
P-HC-4523	12-304	1/4" Hose Fitting x 1/4" NPS(f)
P-HC-4527	12-301	5/16" Hose Fitting x 1/4" NPS(f)
P-HC-4528	12-303	3/8" Hose Fitting x 1/4" NPS(f)
P-HC-4543	12-306	1/4" Hose Fitting x 3/8" NPS(f)
P-HC-4548	12-302	3/8" Hose Fitting x 3/8" NPS(f)
P-HC-4551	12-368	1/2" Hose Fitting x 3/8" NPS(f)
P-HC-4599	12-305	5/16" Hose Fitting x 1/4" NPT(m)
PT-33-1	56-97	Tank Lid Gasket, 2-1/2 Gallon, Stratoprene
QM-1458-1	56-98	Tank Lid Gasket, 5 & 15 Gallon, Stratoprene
QM-1462	56-93	Tank Lid Gasket, 2 Gallon, Stratoprene
QMS-67	56-94	Tank Lid Gasket, 2 Gallon, Stratoprene
QMS-80-1	56-95	Tank Lid Gasket, 2-1/2 Gallon, Stratoprene
QS-100	10-1652	Oil Seal
SS-1215	12-1480	Plug, 1/8" NPT
SS-1216	12-1481	Plug, 1/4" NPT
SS-1217	12-1483	Plug, 3/8" NPT
SS-7312-K5	55-1164	Gaskets (Kit of 5)
SSG-8069-K25	55-2358	O-Rings (Kit of 25)
SSG-8182-K5	55-1961	O-Rings (Kit of 5)
SSP-3-CD	12-465	Swivel Adapter, 1/2" NPT(m) x 1/2" NPS(f)
SSP-7-CD	12-405	Swivel Adapter, 3/8" NPT(m) x 3/8" NPS(f)
SSP-14-CD	12-403	Swivel Adapter, 1/4" NPT(m) x 3/8" NPS(f)
SSP-25-CD	12-404	Swivel Adapter, 3/8" NPT(m) x 1/4" NPS(f)
SST-8405-K5	55-1140	Retaining Rings (Kit of 5)
SST-8434	19-1741	Retaining Ring
TGC-9-K5	55-87	Gaskets (Kit of 5)
TIA-5080	29-1676	ASME Air Relief Safety Valve - 80 PSI
TIA-5110	29-941	ASME Air Relief Safety Valve - 110 PSI

BEDFORD® Replacement Parts For . . . ASM Equipment

To order, contact your local
Paint Spray Equipment Dealer and ask for
Genuine Bedford Replacement Parts.

REPLACES ASM PART NO.	BEDFORD PART NO.	DESCRIPTION
3027-F	—	Only available as: 4427-G (20-2393)
3027-G	—	Order as: 4427-G (20-2393)
4402-G	58-2385	Diffuser - 300/400 Gun (7/8 "G" Thread)
4404	47-2227	Ball Mount & Valve Plunger Assembly
4405	47-2229	Ball Mount Assembly
4412	6-2223	External Seal
4425	55-2226	Valve Stem Locknuts (3-pack)
4426-G	20-2392	Kit - 300/400 Gun ("G" Diffuser & Ball Mount)
4427-G	20-2393	Kit - 300/400 Gun ("G" Diffuser, Ball/Plunger)
4428	47-2235	Valve Plunger Assembly - 300/400 Gun
4433-2	55-2721	Gun Filters, 50 Mesh, White, Medium (2-Pk)
4434-2	55-2722	Gun Filters, 100 Mesh, Yellow, Fine (2-Pk)
4435-2	55-2723	Gun Filters, 200 Mesh, Red, Extra-Fine (2-Pk)
4436-2	55-2724	Gun Filters, 30 Mesh, Green, Coarse (2-Pk)
070289	22-2771	Sealant

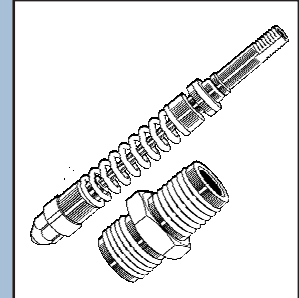

PART NO. 20-2393
REPLACES 4427-G

Note: 6-digit ASM part numbers are listed in the Graco section beginning below...

BEDFORD® Replacement Parts For . . . GRACO / ASM Equipment

To order, contact your local
Paint Spray Equipment Dealer and ask for
Genuine Bedford Replacement Parts.

REPLACES GRACO PART NO.	BEDFORD PART NO.	DESCRIPTION
061-089	13-6	3/8" Red Smooth Air Hose, Reel, 250 PSI
061-204	13-4	1/4" Red Smooth Air Hose, Reel, 250 PSI
061-207	13-59	5/16" Red Smooth Air Hose, Reel, 250 PSI
070-289	22-2771	Sealant
100-040	12-1483	Plug, 3/8" NPT
100-063	19-258	Pin
100-064	9-630	Ball
100-065	9-657	Ball
100-069	9-255	Ball
100-084	9-690	Ball
100-103	19-391	Cotter Pin
100-114	9-610	Ball
100-148	9-691	Ball
100-279	9-127	Ball
100-332	9-693	Ball
100-400	9-669	Ball
100-403	12-1480	Plug, 1/8" NPT
100-454	19-1618	Screw
100-509	12-1481	Plug, 1/4" NPT
100-721	12-1482	Plug, 1/4" NPT with Hex Socket End
100-846	12-1309	Grease Fitting
100-960	28-719	Gauge, 1/4" NPT Btm Mnt, 0-200 PSI, 2"
101-178	9-128	Ball
101-190	9-617	Ball
101-201	12-368	1/2" Hose Fitting x 3/8" NPS(f)



PART NO. 53-1093 3/8"
REPLACES 101-891 DIA

PART NO. 53-1096 5/8"
REPLACES 101-892 DIA

To order, contact your local
Paint Spray Equipment Dealer and ask for
Genuine Bedford Replacement Parts.

BEDFORD® Replacement Parts For . . . GRACO / ASM Equipment

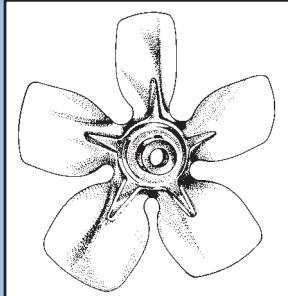

PART NO. 17-1236
REPLACES 102-654

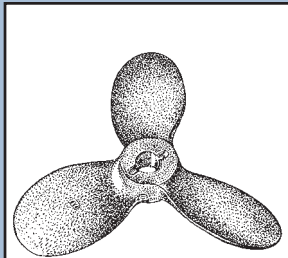

PART NO. 46-1062
REPLACES 159-854

REPLACES GRACO PART NO.	BEDFORD PART NO.	DESCRIPTION
101-274	19-392	Cotter Pin
101-391	19-1248	Pin
101-454	9-1239	Ball
101-545	19-393	Cotter Pin
101-701	9-1554	Ball
101-718	9-1258	Ball
101-750	9-883	Ball
101-822	9-995	Ball
101-823	9-129	Ball
101-859	9-996	Ball
101-874	9-130	Ball
101-890	19-763	Screw
101-891	53-1093	Brush, 3/8" Diameter
101-892	53-1096	Brush, 5/8" Diameter
101-917	9-153	Ball
101-946	19-394	Cotter Pin
101-947	9-244	Ball
101-956	9-245	Ball
101-968	9-695	Ball
102-119	9-1895	Ball
102-233	9-897	Ball
102-310	19-1393	Nut
102-366	19-461	Screw
102-413	43-1249	Packing
102-416	43-1250	Packing
102-417	43-1251	Packing
102-418	43-1252	Packing
102-596	15-818	Teflon O-Ring
102-642	—	Replaced by 106-260 (15-1695)
102-654	17-1236	Impeller
102-727	0-668	O-Ring
102-737	0-3089	O-Ring, King Air Motor
102-861	0-1063	O-Ring
102-867	0-1053	O-Ring
102-930	0-1064	O-Ring
102-952	—	Replaced by 181-073 (14-1224)
102-969	22-592	Adhesive
102-972	9-839	Ball
102-973	9-692	Ball
102-974	9-1747	Ball
102-982	15-3065	Teflon O-Ring
103-185	0-1040	O-Ring
103-186	6-862	Backup Ring
103-337	0-836	O-Ring
103-338	0-3012	O-Ring
103-413	0-2741	O-Ring
103-605	12-301	5/16" Hose Fitting x 1/4" NPS(f)
103-648	0-877	O-Ring
103-740	48-972	Switch - EM400
104-084	12-306	1/4" Hose Fitting x 3/8" NPS(f)

BEDFORD® Replacement Parts

For . . . GRACO / ASM Equipment

To order, contact your local
Paint Spray Equipment Dealer and ask for
Genuine Bedford Replacement Parts.

REPLACES GRACO PART NO.	BEDFORD PART NO.	DESCRIPTION
104-319	15-2862	Teflon O-Ring
104-361	15-432	Teflon O-Ring
104-412	12-310	Compression Ring for 1/4" Hose Fittings
104-413	12-312	Compression Ring for 3/8" Hose Fittings
104-414	12-302	3/8" Hose Fitting x 3/8" NPS(f)
104-415	12-304	1/4" Hose Fitting x 1/4" NPS(f)
104-445	0-1106	Packing
104-537	15-2640	Teflon O-Ring
104-804	15-1434	Teflon O-Ring
104-892	15-1057	Teflon O-Ring
104-893	15-1058	Teflon O-Ring
104-928	—	Replaced by 156-082 (0-597)
104-938	0-1847	O-Ring
104-951	—	Replaced by 170-708 (43-829)
105-252	24-1969	Mounting Bracket, Gen'l Purpose Regulator
105-444	9-140	Ball
105-445	9-183	Ball
105-496	—	Replaced by Graco 166-411 (15-395)
105-522	43-1253	Seal
106-093	10-1317	Washer
106-260	15-1695	Teflon O-Ring
106-555	0-3055	O-Ring
106-556	0-2333	O-Ring
107-079	15-2278	Teflon O-Ring
107-082	0-1238	O-Ring
107-093	43-1254	Seal
107-098	15-1543	Teflon O-Ring
107-109	23-1521	Spring
107-110	19-1522	Nut
107-167	9-2371	Ball
107-203	9-2380	Ball
107-245	—	Replaced by 157-785 (12-408)
107-306	0-2379	O-Ring
107-313	15-1990	Teflon O-Ring
107-505	15-2873	Teflon O-Ring
107-536	9-1975	Ball
107-563	0-3056	O-Ring
108-001	9-3103	Ball
108-195	0-1833	O-Ring
108-266	—	Replaced by 154-771 (0-1383)
108-357	0-3090	O-Ring
108-358	0-3091	O-Ring
108-450	19-1261	Cotter Pin
108-451	49-1353	Polyethylene V-Packing
108-452	49-1327	Polyethylene V-Packing
108-453	49-1354	Polyethylene V-Packing
108-454	49-1380	Polyethylene V-Packing
108-455	49-1912	Polyethylene V-Packing
108-456	49-1913	Polyethylene V-Packing
108-526	15-1498	Teflon O-Ring
108-690	43-1540	Seal, U-Cup
108-775	9-1541	Ball
108-822	15-2248	Teflon O-Ring
108-832	0-2633	O-Ring
108-833	0-3073	O-Ring

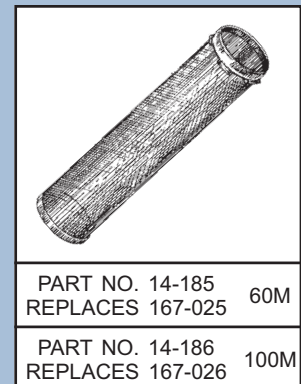
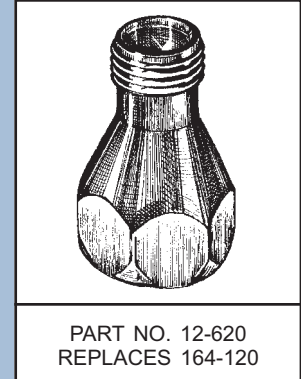

To order, contact your local
Paint Spray Equipment Dealer and ask for
Genuine Bedford Replacement Parts.

BEDFORD® Replacement Parts For . . . GRACO / ASM Equipment

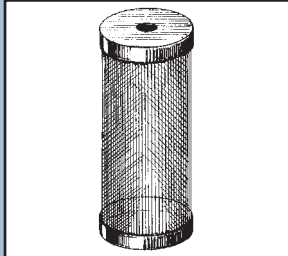

PART NO. 14-193 60M
REPLACES 167-053

PART NO. 14-194 100M
REPLACES 167-054

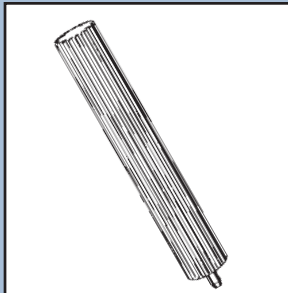

PART NO. 44-1305
REPLACES 171-939

REPLACES GRACO PART NO.	BEDFORD PART NO.	DESCRIPTION
108-954 108-958 108-982 109-213 109-303	15-1512 12-1981 12-1976 15-3092 2-2291	Teflon O-Ring Connector, 45° Connector, Push-On Teflon O-Ring Teflon V-Packing
109-450 109-451 109-499 110-082 110-110	15-3066 15-1890 15-2644 19-3013 22-2315	Teflon O-Ring Teflon O-Ring Teflon O-Ring Retaining Ring Sealant
110-165 110-209 110-241 110-242 110-321	— 24-1972 0-1788 0-1789 24-1968	Replaced by 108-526 (15-1498) Mounting Nut, Mini-Regulator O-Ring O-Ring Mounting Bracket & Nut, Mini-Regulator
110-636 111-316 111-317 111-450 111-453	15-1826 0-3074 19-1977 0-3067 9-3126	Teflon O-Ring O-Ring, Solvent Resistant Retaining Clip O-Ring, Solvent Resistant Ball, Ceramic
111-457 111-507 111-516 111-599 111-600	15-2861 0-3098 0-3075 10-2322 19-2807	Teflon O-Ring O-Ring, Solvent Resistant O-Ring, Solvent Resistant Washer, Flat Grooved Pin, 1" Long
111-603 111-613 111-699 111-710 111-711	15-1792 4-2360 — 0-2364 6-2363	Teflon O-Ring Cup Packing Replaced by 277-364 (20-2865) O-Ring Backup Ring
112-264 112-319 112-561 112-588 112-589	9-3130 0-2431 43-2688 — 43-2249	Ball O-Ring, Solvent Resistant U-Cup Packing Replaced by 108-822 (15-2248) U-Cup Seal
112-590 112-591 112-592 112-593 112-604	17-2907 1-2250 49-2251 19-2252 14-2779	Plug, Throat Seal Leather V-Packing Polyethylene V-Packing Ball Stop Pin Inlet Strainer, 1" NPT, 8 Mesh, Single Screen
112-721 112-722 113-137 113-406 113-423	9-2312 9-2313 0-3059 — 0-2689	Ball Ball O-Ring, Solvent Resistant Order as: Bedford 26-1125 Regulator O-Ring
114-049 114-054 115-099 115-719 116-327	0-2656 0-2284 10-3019 0-2920 9-3127	O-Ring, Pole Extension O-Ring Intake Washer, Garden Hose Fitting O-Ring Ball, Ceramic
116-377 116-385 117-285 117-459 117-517	15-3137 17-3138 15-2739 0-2597 0-2886	Teflon O-Ring Plug Teflon O-Ring O-Ring O-Ring, Solvent Resistant

BEDFORD® Replacement Parts

For . . . GRACO / ASM Equipment

To order, contact your local
Paint Spray Equipment Dealer and ask for
Genuine Bedford Replacement Parts.

REPLACES GRACO PART NO.	BEDFORD PART NO.	DESCRIPTION
117-559	0-2740	O-Ring, Solvent Resistant
117-610	0-3057	O-Ring, Solvent Resistant
117-828	15-2599	O-Ring, Encapsulated, Outlet Filter
118-494	0-2657	O-Ring
118-503	52-2658	Wiper
118-504	52-2666	Wiper
118-594	0-3058	O-Ring, Solvent Resistant
118-600	23-3015	Spring
118-601	9-3189	Ball
118-602	9-3190	Ball
118-948	6-2683	Teflon Backup Ring
119-252	23-2320	Spring
119-259	9-3191	Ball, Ceramic
119-636	52-2910	Wiper, Piston
119-790	0-3093	O-Ring
119-799	53-2777	Brush, 3/8" Diameter
120-733	0-3017	O-Ring
120-777	0-2880	O-Ring, Solvent Resistant
120-818	0-3032	O-Ring
150-179	3-101	Leather Cup
150-429	10-1090	Gasket
150-516	18-636	Male Gland
150-522	23-625	Spring
150-540	10-803	Washer
150-647	10-683	Gasket
150-670	10-776	Gasket
151-519	12-1978	Nipple, 1/8" NPT x 1/4" NPT
154-594	0-1246	O-Ring
154-662	0-144	O-Ring
154-771	0-1383	O-Ring
154-986	12-404	Swivel Adapter 3/8" NPT(m) x 1/4" NPS(f)
155-470	12-418	Swivel Adapter 1/2" NPT(m) x 1/2" NPS(f) 90°
155-570	12-409	Swivel Adapter 1/4" NPT(f) x 1/4" NPS(f)
155-665	12-405	Swivel Adapter 3/8" NPT(m) x 3/8" NPS(f)
155-685	0-1107	Packing
155-865	12-412	Swivel Adapter 1/2" NPT(f) x 1/2" NPS(f)
156-082	0-597	O-Ring
156-172	12-413	Swivel Adapter 3/4" NPT(f) x 3/4" NPS(f)
156-173	12-251	Swivel Adapter 3/8" NPT(f) x 3/8" NPS(f)
156-401	0-2433	O-Ring
156-454	0-330	O-Ring
156-589	12-415	Swivel Adapter 3/4" NPT(f) x 3/4" NPS(f) 90°
156-593	0-957	O-Ring
156-633	0-139	O-Ring
156-641	0-102	O-Ring
156-684	12-465	Swivel Adapter 1/2" NPT(m) x 1/2" NPS(f)
156-698	0-103	O-Ring
156-766	10-1424	Gasket
156-811	3-253	Leather Cup
156-823	12-402	Swivel Adapter 1/4" NPT(m) x 1/4" NPS(f)
156-849	12-230	Nipple 3/8" NPT x 3/8" NPT
156-971	12-228	Nipple 1/4" NPT x 1/4" NPT
157-127	10-1264	Gasket
157-195	0-2908	O-Ring, Spacer
157-250	0-331	O-Ring

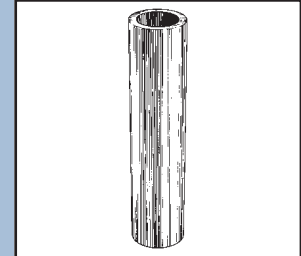

PART NO. 57-1403
REPLACES 178-898

PART NO. 57-1405
REPLACES 178-902



PART NO. 57-1406
REPLACES 178-899

PART NO. 57-1408
REPLACES 178-888

To order, contact your local
Paint Spray Equipment Dealer and ask for
Genuine Bedford Replacement Parts.

BEDFORD® Replacement Parts For . . . GRACO / ASM Equipment

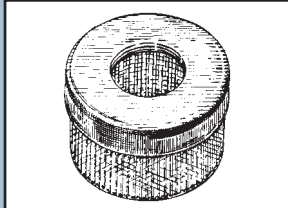

PART NO. 14-1224 REPLACES 181-073	1/2"
PART NO. 14-1428 REPLACES 183-770	3/4"
PART NO. 14-1223 REPLACES 181-072	1"
PART NO. 14-2179 REPLACES 189-920	1"

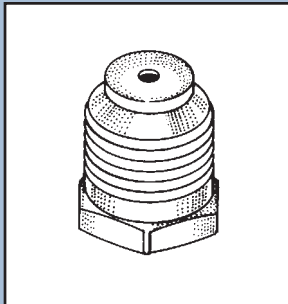

PART NO. 12-1486
REPLACES 181-085

REPLACES GRACO PART NO.	BEDFORD PART NO.	DESCRIPTION
157-277	0-694	O-Ring
157-350	12-229	Nipple 1/4" NPT x 3/8" NPT
157-416	12-431	Swivel Adapter 1/2"NPT(f) x 1/2"NPS(f) 90°
157-628	0-142	O-Ring
157-630	23-1646	Spring
157-633	23-1647	Spring
157-636	18-398	Female Gland
157-637	1-104	Leather V-Packing
157-638	18-397	Male Gland
157-676	12-201	Swivel Adapter 1/4"NPT(f) x 1/4"NPS(f) 90°
157-705	12-403	Swivel Adapter 1/4" NPT(m) x 3/8" NPS(f)
157-785	12-408	Swivel Adapter 3/4" NPT(m) x 3/4" NPS(f)
157-894	18-635	Female Gland
158-109	5-105	Rubber Gasket
158-256	12-407	Swivel Adapter 1/2" NPT(m) x 3/8" NPS(f)
158-367	16-842	Grommet
158-378	0-132	O-Ring
158-379	0-135	O-Ring
158-402	3-149	Leather Cup
158-486	0-138	O-Ring
158-491	12-231	Nipple 1/2" NPT x 1/2" NPT
158-776	0-2758	O-Ring
158-882	3-233	Flange Packing
159-239	12-232	Nipple 3/8" NPT x 1/2" NPT
159-308	11-584	V-Packing
159-312	18-1041	Male Gland
159-314	1-150	V-Packing
159-471	17-1263	Spreader
159-854	46-1062	Propeller
15A-704	0-3068	O-Ring
15A-968	58-2756	Intake Seat
15B-112	15-2598	Teflon O-Ring
15B-958	0-3094	O-Ring
15C-011	—	Available in 246-429 (20-2757) Intake Valve
15C-987	18-2659	Male Gland
15C-988	18-2660	Female Gland
15C-989	18-2667	Male Gland
15C-997	10-2661	Backup Washer
15C-998	10-2669	Backup Washer
15D-252	0-3099	O-Ring, Solvent Resistant
15D-371	0-3100	O-Ring, Solvent Resistant
15E-022	58-2317	Seat
15E-329	1-2718	Leather V-Packing
15E-639	49-2916	Polyethylene V-Packing
15F-183	10-2915	Backup Washer
15F-875	49-2909	Polyethylene V-Packing
15G-234	52-2743	Wiper, Piston
15G-282	18-3140	Male Gland
15G-283	18-3141	Female Gland
15G-284	49-3142	Polyethylene V-Packing
15G-285	49-3143	Polyethylene V-Packing
15G-657	18-2911	Female Gland, upper
15G-658	18-2912	Male Gland, upper
15H-250	18-3144	Male Gland
15H-251	18-3145	Female Gland

BEDFORD® Replacement Parts

For . . . GRACO / ASM Equipment

To order, contact your local
Paint Spray Equipment Dealer and ask for
Genuine Bedford Replacement Parts.

REPLACES GRACO PART NO.	BEDFORD PART NO.	DESCRIPTION
15J-800	10-2913	Backup Washer
160-011	3-243	Leather Packing
160-015	0-903	O-Ring
160-020	3-181	Leather Cup
160-028	0-422	O-Ring
160-158	10-686	Gasket
160-170	5-145	Gasket
160-240	7-569	Packing
160-258	0-1105	Packing
160-260	—	Order as: (1) pc 170-708 & (1) pc 160-896
160-261	44-838	Nut
160-325	0-254	O-Ring
160-430	28-759	Gauge, 1/4" NPT Btm Mount, 0-100 PSI, 2"
160-618	23-837	Wire
160-621	0-133	O-Ring
160-624	0-616	Packing
160-625	0-134	O-Ring
160-634	16-801	Packing
160-644	16-1605	Flat Packing
160-671	10-1606	Gasket, Copper
160-672	18-1607	Guide, Upper
160-673	16-1608	Packing, Upper
160-674	6-1609	Washer, Backup
160-675	18-1610	Guide, Lower
160-678	18-1611	Guide, Displacement Tube
160-679	16-1612	Packing
160-680	6-1613	Guide, Displacement Tube
160-681	8-1614	Nylon Seal
160-721	0-1054	O-Ring
160-896	44-835	Stem
161-077	12-411	Swivel Adapter 1/2" NPT(f) x 3/8" NPS(f)
161-355	—	Replaced by 171-912 (10-859)
161-387	0-423	O-Ring
161-397	0-421	O-Ring
161-416	0-141	O-Ring
161-547	0-961	O-Ring
161-553	10-688	Gasket
161-559	7-679	Washer
161-560	16-633	Packing
161-561	—	Replaced by 214-852 (47-1662)
161-562	11-433	V-Packing
161-563	7-234	Backup Leather
161-569	10-434	Seal
161-572	0-1039	O-Ring
161-575	23-1648	Spring
161-578	0-462	O-Ring
161-589	23-1649	Spring
161-635	10-687	Gasket
161-647	—	Replaced by 172-688 (8-977)
161-673	10-1267	Gasket
161-788	4-342	Piston Cup Seal
161-789	42-819	Bearing
161-793	4-343	Piston Cup Seal
161-794	42-820	Bearing
161-950	8-505	Nylon Packing

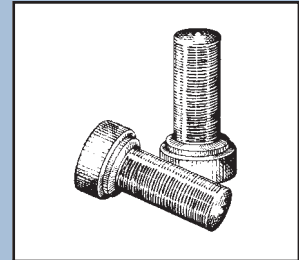

PART NO. 14-151 100M
REPLACES 205-264

PART NO. 14-152 60M
REPLACES 205-265

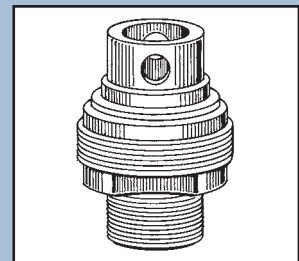

PART NO. 58-1583
REPLACES 205-981

PART NO. 58-1582
REPLACES 206-399

To order, contact your local
Paint Spray Equipment Dealer and ask for
Genuine Bedford Replacement Parts.

BEDFORD® Replacement Parts For . . . GRACO / ASM Equipment

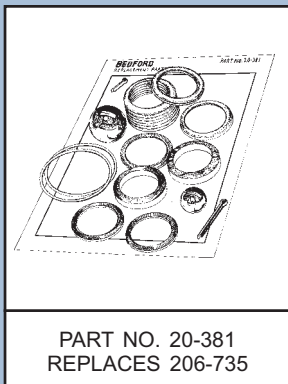
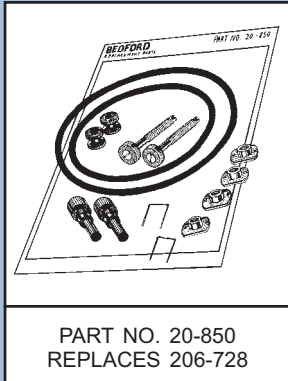

REPLACES GRACO PART NO.	BEDFORD PART NO.	DESCRIPTION
162-302	8-504	Nylon Packing
162-309	8-510	Nylon Packing
162-391	1-703	Leather V-Packing
162-453	12-219	Nipple 1/4" NPT x 1/4" NPS
162-505	12-406	Swivel Adapter 3/8" NPT(m) x 1/2" NPS(f)
162-636	3-235	Flange Packing
162-642	3-236	Leather Cup
162-694	1-670	Leather V-Packing
162-841	0-604	O-Ring
162-863	8-122	Nylon Tip Gasket 5/32" (Thick)
162-865	4-109	Teflon Cup Packing
162-866	2-110	Teflon V-Packing
162-867	4-373	Teflon Flange Packing
162-868	4-372	Teflon Cup Packing
162-870	4-993	Packing
162-871	4-237	Teflon Cup Packing
162-898	10-981	Gasket
162-989	5-106	Gasket
163-010	7-108	Backup Washer
163-011	11-107	V-Packing
164-075	8-162	Base, Tip Filter
164-111	8-241	Gasket
164-112	23-702	Spring
164-116	7-120	Packing
164-120	12-620	Filter Retainer / Adapter, Stainless Steel
164-396	—	Replaced by 179-983 (18-1082)
164-397	1-111	Leather V-Packing
164-398	—	Replaced by 179-984 (18-1083)
164-477	1-115	Leather V-Packing
164-480	6-378	Teflon Gasket
164-481	—	Replaced by 178-902 (57-1405)
164-555	2-678	Teflon V-Packing
164-557	15-171	Teflon O-Ring
164-622	15-424	Teflon O-Ring
164-623	15-671	Teflon O-Ring
164-627	16-747	Seal
164-651	—	Replaced by 178-899 (57-1406)
164-652	6-388	Teflon Gasket
164-654	12-1479	Retainer
164-655	—	Replaced by 186-132 (18-2159)
164-656	1-117	Leather V-Packing
164-657	—	Replaced by 186-133 (18-1905)
164-659	—	Replaced by 178-900 (57-1407)
164-713	18-383	Packing Retainer
164-714	—	Replaced by 179-987 (18-1087)
164-715	1-112	Leather V-Packing
164-716	—	Replaced by 179-988 (18-1088)
164-778	42-148	Bearing
164-782	15-427	Teflon O-Ring
164-788	42-119	Bearing
164-837	18-609	Male Gland
164-846	15-460	Teflon O-Ring
164-862	2-116	Teflon V-Packing
164-891	15-172	Teflon O-Ring
164-900	8-242	Backup Washer

BEDFORD® Replacement Parts

For . . . GRACO / ASM Equipment

To order, contact your local
Paint Spray Equipment Dealer and ask for
Genuine Bedford Replacement Parts.

REPLACES GRACO PART NO.	BEDFORD PART NO.	DESCRIPTION
164-902	—	Replaced by 172-094 (8-896)
164-912	2-113	Teflon V-Packing
164-913	2-114	Teflon V-Packing
164-918	2-118	Teflon V-Packing
164-920	4-390	Teflon Cup Packing
164-964	15-238	Teflon O-Ring
165-052	15-239	Teflon O-Ring
165-098	2-167	Teflon V-Packing
165-104	2-165	Teflon V-Packing
165-109	2-591	Teflon V-Packing
165-274	12-1394	Stud, 1/4" NPT(m)
165-287	6-651	Bearing
165-288	18-650	Female Gland
165-289	—	Replaced by 166-133 (11-1750)
165-292	6-514	Piston Bearing
165-295	0-612	O-Ring
165-592	—	Replaced by 181-085 (12-1486)
165-599	12-1395	Stud, 3/8" NPT(m)
165-651	2-240	Teflon V-Packing
165-672	2-420	Teflon V-Packing
165-894	18-256	Male Gland
165-895	18-257	Female Gland
165-944	18-978	Male Gland
165-945	18-979	Female Gland
165-964	12-1396	Nut
166-026	6-511	Piston Seal
166-073	15-469	Teflon O-Ring
166-075	2-437	Teflon V-Packing
166-080	0-143	O-Ring
166-119	0-984	O-Ring
166-133	11-1750	Packing
166-165	2-147	Teflon V-Packing
166-226	2-180	Teflon V-Packing
166-228	18-991	Male Gland
166-229	18-980	Female Gland
166-238	0-841	O-Ring
166-258	7-1382	Packing
166-374	—	Replaced by 168-283 (6-613)
166-375	18-512	Female Gland
166-378	0-717	O-Ring
166-395	8-515	Nylon Packing
166-411	15-395	Teflon O-Ring
166-412	15-396	Teflon O-Ring
166-487	18-1619	Male Gland
166-488	18-1620	Female Gland
166-489	1-341	Leather V-Packing
166-490	1-1113	Packing
166-512	6-608	Washer
166-564	6-1100	Bearing
166-602	3-1076	Leather Cup
166-603	1-1077	Leather V-Packing
166-612	15-507	Teflon O-Ring
166-623	15-463	Teflon O-Ring
166-624	15-466	Teflon O-Ring
166-650	10-804	Gasket

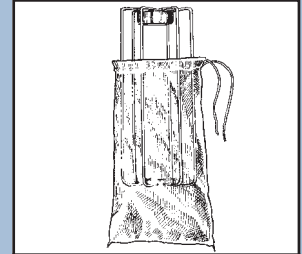

PART NO. 14-700 3/4"
REPLACES 208-241

PART NO. 14-900 1-1/4"
REPLACES 210-726

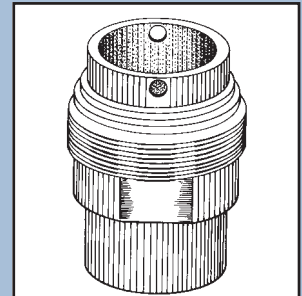

PART NO. 58-2006
REPLACES 207-473

To order, contact your local
Paint Spray Equipment Dealer and ask for
Genuine Bedford Replacement Parts.

BEDFORD® Replacement Parts For . . . GRACO / ASM Equipment

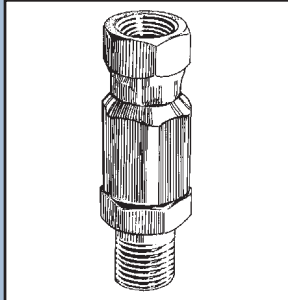

PART NO. 14-1200
REPLACES 210-500

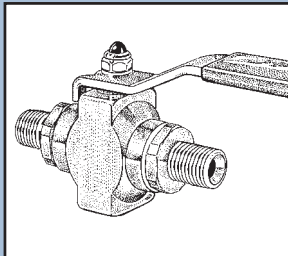

PART NO. 29-1440 1/4"
REPLACES 210-657

PART NO. 29-1441 3/8"
REPLACES 210-658

REPLACES GRACO PART NO.	BEDFORD PART NO.	DESCRIPTION
166-651	10-805	Gasket
166-652	10-1621	Gasket
166-653	10-1622	Gasket
166-702	0-2244	O-Ring
166-769	2-994	Teflon V-Packing
166-770	2-849	Teflon V-Packing
166-811	6-414	Valve Seat
166-815	18-822	Male Gland
166-816	2-435	Teflon V-Packing
166-817	18-823	Female Gland
166-969	8-173	Nylon Tip Washer 1/16" (Thin)
166-985	15-1103	Teflon O-Ring
166-987	4-1160	Packing
167-024	14-184	Strainer, Manifold Filter - 30 Mesh (Long)
167-025	14-185	Strainer, Manifold Filter - 60 Mesh (Long)
167-026	14-186	Strainer, Manifold Filter - 100 Mesh (Long)
167-027	14-187	Strainer, Manifold Filter - 200 Mesh (Long)
167-052	14-192	Strainer, Manifold Filter - 30 Mesh (Short)
167-053	14-193	Strainer, Manifold Filter - 60 Mesh (Short)
167-054	14-194	Strainer, Manifold Filter - 100 Mesh (Short)
167-055	14-195	Strainer, Manifold Filter - 200 Mesh (Short)
167-077	—	Replaced by 178-898 (57-1403)
167-354	18-997	Male Gland
167-355	18-998	Male Gland
167-585	23-1650	Spring
167-664	18-1365	Female Gland
167-665	2-848	Teflon V-Packing
167-666	1-1326	Leather V-Packing
167-667	18-1366	Male Gland
167-668	6-1350	Gasket
167-730	10-684	Gasket
167-893	—	Replaced by 178-894 (57-1409)
167-894	6-854	Gasket
167-896	—	Replaced by 186-130 (18-1656)
167-897	1-464	Leather V-Packing
167-898	2-468	Teflon V-Packing
167-899	—	Replaced by 186-131 (18-1902)
167-901	—	Replaced by 178-888 (57-1408)
167-969	8-1078	Bearing
167-971	16-1184	Piston Seal
167-972	0-985	O-Ring
168-110	0-1104	O-Ring
168-183	10-689	Gasket
168-283	6-613	Bearing
168-285	6-614	Bearing
168-506	16-1072	Packing
168-517	12-1201	Housing
168-518	0-3177	O-Ring
168-521	10-1455	Copper Washer
168-548	2-216	Teflon V-Packing
168-851	18-1615	Male Gland
168-852	18-1616	Bearing
169-133	18-1042	Female Gland
169-429	2-340	Teflon V-Packing
169-605	18-538	Female Gland

BEDFORD® Replacement Parts

For . . . GRACO / ASM Equipment

To order, contact your local
Paint Spray Equipment Dealer and ask for
Genuine Bedford Replacement Parts.

REPLACES GRACO PART NO.	BEDFORD PART NO.	DESCRIPTION
169-606	18-537	Male Gland
169-607	1-590	Leather V-Packing
169-608	2-426	Teflon V-Packing
169-967	12-1332	Quick Disconnect Plug 1/4" NPT(f)
169-970	12-1333	Quick Disconnect Plug 1/4" NPT(m)
169-971	12-1334	Quick Disconnect Plug 3/8" NPT(m)
16X-431	20-3193	Kit - TexSpray Mark X, GMax 7900HD
170-101	10-1265	Gasket
170-110	10-596	Washer
170-240	—	Use 4' x 3/4" Fluid Hose (13-1190)
170-607	—	Replaced by 206-345 (58-1584)
170-608	—	Replaced by 206-345 (58-1584)
170-625	49-737	Packing
170-706	13-2557	4' x 1" ID Suction Hose (Cut Length)
170-708	43-829	Poppet
170-709	43-828	Poppet
170-959	—	Replaced by 181-072 (14-1223)
171-146	18-667	Male Gland
171-163	18-1623	Gasket
171-590	17-861	Spreader
171-593	10-866	Washer
171-594	10-825	Washer
171-912	10-859	Gasket
171-913	10-860	Gasket
171-939	44-1305	Filter Support (Aluminum), Outlet Manifold
171-941	23-1563	Spring, Manifold Outlet Filter
171-942	12-1564	Head, Manifold Outlet Filter
172-094	8-896	Seat
172-383	—	Replaced by 178-543 (18-1467)
172-384	1-583	Leather V-Packing
172-385	18-1463	Male Gland
172-392	3-578	Leather Cup
172-423	18-857	Male Gland
172-424	18-858	Female Gland
172-487	2-577	Teflon V-Packing
172-489	4-1464	Teflon Cup
172-580	17-203	Spreader
172-688	8-977	Washer
172-831	44-1565	Bowl, Manifold Outlet Filter
172-846	1-940	Leather V-Packing
172-871	2-919	Teflon V-Packing
176-167	49-1115	Gasket
176-648	—	Replaced by 181-084 (12-1587)
176-747	18-1282	Female Gland
176-749	1-1240	Leather V-Packing
176-750	18-1283	Male Gland
176-751	19-2628	Lower Packing Nut - Ultra 400, 390st, 490st
176-754	18-1284	Male Gland
176-755	1-1241	Leather V-Packing
176-756	—	Replaced by 176-997 (49-1276)
176-757	18-1285	Female Gland
176-759	19-1286	Pin
176-761	10-1287	Gasket
176-818	44-2654	Attach Pin
176-882	49-1275	V-Packing

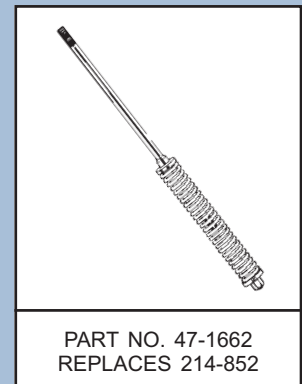
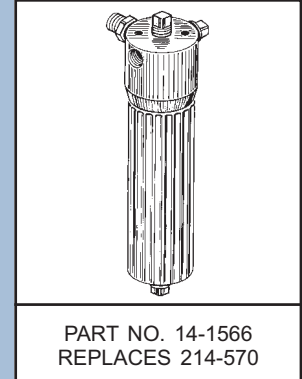

To order, contact your local
Paint Spray Equipment Dealer and ask for
Genuine Bedford Replacement Parts.

BEDFORD® Replacement Parts For . . . GRACO / ASM Equipment

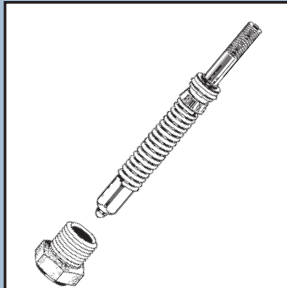

PART NO. 20-1502
REPLACES 218-070

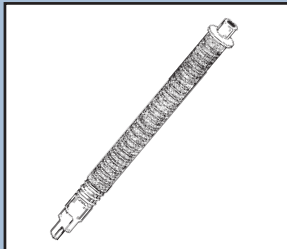

PART NO. 14-1484 50M
REPLACES 218-131

PART NO. 14-1485 100M
REPLACES 218-133

REPLACES GRACO PART NO.	BEDFORD PART NO.	DESCRIPTION
176-884	8-1288	Backup Washer
176-920	—	Replaced by 188-150 (13-499)
176-997	49-1276	V-Packing
177-159	49-1465	Cup Packing
177-164	49-1466	Packing
177-222	49-1523	Needle Packing
177-223	18-1524	Gland
177-929	57-1435	Cylinder - EM390, EM490, Ultra 400/500
178-543	18-1467	Female Gland
178-743	12-1397	Valve Housing
178-745	12-1398	Valve Stem
178-746	9-1257	Valve Ball
178-747	20-1446	Heavy Duty Lever Kit - Ball Valve
178-888	57-1408	Rod - 45:1 King, GH733, 20:1 Bulldog (SD)
178-894	57-1409	Sleeve - 45:1 King, GH733, 20:1 Bulldog (SD)
178-898	57-1403	Sleeve - 23:1 Monark, EH333 (SD)
178-899	57-1406	Rod - 30:1 Bulldog, GH533, 63:1 King (SD)
178-900	57-1407	Sleeve - 30:1 Bull, GH533, 63:1 King (SD)
178-902	57-1405	Sleeve - 30:1 Pres, EH433GT, GH433 (SD)
178-938	19-1289	Pin
178-939	1-1242	Leather V-Packing
178-940	1-1243	Leather V-Packing
178-942	18-1294	Male Gland
178-943	18-1295	Female Gland
178-944	18-1296	Male Gland
178-945	19-2629	Lower Packing Nut - GM3500, Ultra 1000
178-949	57-1439	Cylinder - Ultra 333/433/750/1000, GM3500
178-964	49-1297	V-Packing
178-965	49-1298	V-Packing
178-969	18-1299	Female Gland
179-722	8-1476	Retainer
179-731	14-1118	Gun Filter Element - 50 Mesh, Coarse
179-732	14-1120	Gun Filter Element - 100 Mesh, Fine
179-733	8-3104	Seal, Contractor Gun Handle
179-750	8-1475	Retainer
179-762	10-1525	Washer, Backup
179-763	23-1478	Spring
179-810	17-2422	Plug
179-957	8-1477	Retainer
179-983	18-1082	Gland
179-984	18-1083	Male Gland
179-987	18-1087	Gland
179-988	18-1088	Gland
17A-578	20-3198	Kit - GMax II 7900, TexSpray 7900 / Mark X
17D-481	57-3101	Cylinder - 395/495 stPro, Ultra 695
17D-601	20-3097	Kit - EH200, GH200, GH230, GH300
180-073	18-1290	Female Gland
180-161	—	Replaced by 186-652 (18-1846)
180-656	17-2424	Plug
181-072	14-1223	Inlet Strainer - 1" NPT (Stainless Steel Cap)
181-072P	14-2353	Inlet Strainer - 1" NPT (Nylon Cap)
181-073	14-1224	Inlet Strainer - 1/2" NPT (Stainless Steel Cap)
181-073P	14-2351	Inlet Strainer - 1/2" NPT (Nylon Cap)
181-084	12-1587	Gun Adapter - Binks Gun to RAC Tip
181-085	12-1486	Gun Adapter - RAC, Pole Gun, Wagner Gun

BEDFORD® Replacement Parts

For . . . GRACO / ASM Equipment

To order, contact your local
Paint Spray Equipment Dealer and ask for
Genuine Bedford Replacement Parts.

REPLACES GRACO PART NO.	BEDFORD PART NO.	DESCRIPTION
181-338	18-1301	Backup Washer
181-879	57-1360	Rod - Ultra 400/500, EM380/390/490
183-171	17-1542	Plug
183-172	6-1539	Teflon Packing
183-173	19-1544	Pin, Ball Stop
183-174	1-1545	Leather V-Packing
183-175	1-1546	Leather V-Packing
183-176	18-1547	Male Gland
183-177	18-1548	Female Gland
183-178	18-1549	Male Gland
183-181	57-2383	Cylinder - GM5000, GM10000, Ultra 1500
183-182	49-1550	V-Packing
183-183	49-1551	V-Packing
183-184	—	Replaced by 186-653 (18-1904)
183-185	18-1553	Female Gland
183-239	—	Replaced by 183-563 (57-1748)
183-361	57-1599	Sleeve - GM5000, Ultra 1500, GM 10000
183-548	58-1979	Seat - Thumb Screw Dump Valve
183-555	19-1516	Pin
183-563	57-1748	Rod - Ultra 400/500, EM380/390/490
183-571	57-1749	Sleeve - Ultra 400/500, EM380/390/490
183-616	8-3105	Washer
183-640	18-1371	Male Gland
183-641	18-1372	Female Gland
183-642	18-1373	Male Gland
183-643	18-1374	Female Gland
183-644	18-1375	Male Gland
183-645	18-1376	Female Gland
183-770	14-1428	Inlet Strainer - 3/4" NPT (Stainless Steel Cap)
183-770P	14-2352	Inlet Strainer - 3/4" NPT (Nylon Cap)
183-978	2-1899	Teflon V-Packing
184-198	18-2292	Female Gland
184-248	18-2293	Male Gland
184-300	1-3029	Leather V-Packing
184-303	1-2290	Leather V-Packing
184-307	1-3139	Leather V-Packing
185-211	57-2423	Cylinder - GM3500, Ultra 1000
185-213	57-1911	Sleeve - Ultra 750/1000, GM3500
185-385	10-1903	Shim
186-130	18-1656	Male Gland
186-131	18-1902	Female Gland
186-132	18-2159	Male Gland
186-133	18-1905	Female Gland
186-181	18-1896	Female Gland
186-182	18-1897	Male Gland
186-194	18-1914	Female Gland
186-196	18-1916	Male Gland
186-198	18-1917	Female Gland
186-199	18-1918	Backup Washer
186-652	18-1846	Backup Washer
186-653	18-1904	Backup Washer
187-060	8-1980	Gasket
187-147	—	Replaced by 181-072 (14-1223)
187-190	—	Replaced by 183-770 (14-1428)
187-613	57-1948	Rod - 390st

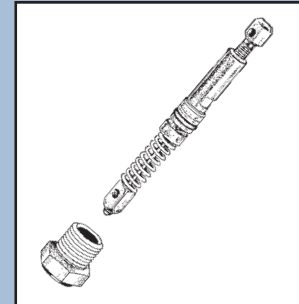

PART NO. 20-1401
REPLACES 218-143

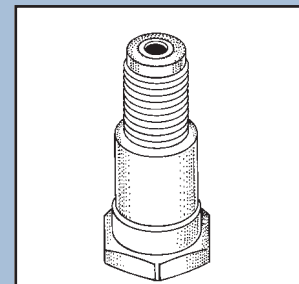

PART NO. 58-1461
REPLACES 218-197

To order, contact your local
Paint Spray Equipment Dealer and ask for
Genuine Bedford Replacement Parts.

BEDFORD® Replacement Parts For . . . GRACO / ASM Equipment

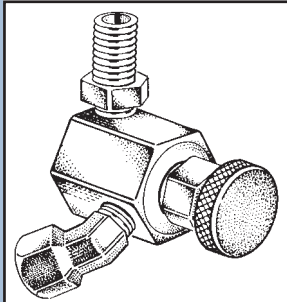

PART NO. 29-1974
REPLACES 222-198

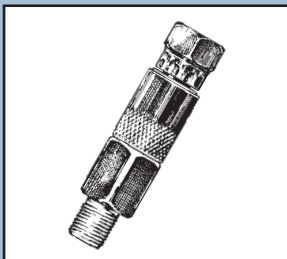

PART NO. 12-1900
REPLACES 223-341

PART NO. 12-2400
REPLACES 239-663

REPLACES GRACO PART NO.	BEDFORD PART NO.	DESCRIPTION
187-615	—	Replaced by 15E-022 (58-2317)
187-621	12-2318	Housing, Drain Valve
187-623	23-2320	Spring
187-634	—	Replaced by 236-786 (57-2131)
187-651	14-3064	Inlet Filter, 3/4"-16 UNF(f)
188-150	13-499	Suction Hose, 3/4" x 3' (No Fittings)
189-584	18-2253	Female Gland
189-585	18-2254	Male Gland
189-587	10-2255	Backup Washer
189-588	18-2256	Female Gland
189-590	6-2257	Gasket
189-920	14-2179	Inlet Strainer - 1" NPT, 8 Mesh, Single Screen
190-180	17-1437	Lever, Ball Valve
192-642	20-2717	Intake Valve Kit - Seat (15/16"), Ball & O-Ring
192-692	49-2285	Polyethylene V-Packing
192-693	49-2286	Polyethylene V-Packing
192-710	49-2279	Polyethylene V-Packing
192-712	49-2280	Polyethylene V-Packing
192-714	—	Replaced by 158-776 (0-2758)
192-729	—	Replaced by 195-368 (23-2402)
192-848	18-2288	Male Gland
193-069	18-2282	Male Gland
193-124	49-2335	Polyethylene V-Packing
193-125	49-2336	Polyethylene V-Packing
193-127	—	Replaced by C20-987 (0-3113)
193-395	58-2867	Intake Seat
193-397	23-2376	Spacer
193-710	8-3106	Seal, Drain Valve
193-722	49-2377	Polyethylene V-Packing
194-117	44-2373	Pin
194-175	18-2372	Female Gland
195-083	14-2650	Outlet Filter, 30 Mesh - for Magnum Pumps
195-129	18-2398	Male Gland
195-134	10-2549	Spacer
195-136	15-2401	Teflon O-Ring
195-368	23-2402	Spacer
195-488	8-2378	Piston Guide
195-523	44-2374	Pin
196-757	—	Replaced by (1) each: 118-504 & 15C-998
196-758	—	Replaced by (1) each: 118-503 & 15C-997
196-759	—	Replaced by 15G-234 (52-2743)
196-762	44-3037	Attach Pin
196-866	58-2712	Intake Seat (1-1/4") - UMax1595, GMax5900
196-880	18-2426	Male Gland
197-332	12-3149	Retainer, Prime Valve
197-443	44-2634	Pin
197-681	12-3151	Housing, Prime Valve
198-303	42-2574	Guide
198-701	49-2635	Polyethylene V-Packing
198-718	1-2636	Leather V-Packing
198-765	18-2637	Female Gland
198-768	18-2638	Male Gland, upper
198-967	18-2573	Male Gland
204-164	20-1617	Kit - 45:1 Fireball
204-940	—	Replaced by 239-663 (12-2400)

BEDFORD® Replacement Parts

For . . . GRACO / ASM Equipment

To order, contact your local
Paint Spray Equipment Dealer and ask for
Genuine Bedford Replacement Parts.

REPLACES GRACO PART NO.	BEDFORD PART NO.	DESCRIPTION
205-139	—	Replaced by 210-867 (13-354)
205-142	13-481	25' x 3/8" Fluid Hose Assembly
205-143	13-482	50' x 3/8" Fluid Hose Assembly
205-160	13-485	15' x 3/8" Fluid Hose Assembly
205-264	14-151	Tip Filter, 100 Mesh, Fine, Enamel & Stain
205-265	14-152	Tip Filter, 60 Mesh, Coarse, Latex
205-516	58-1768	Piston Valve - 30:1 Bull, GH533, 63:1 King
205-538	58-1581	Piston Valve - EH333, 23:1 Monark
205-981	58-1583	Intake Valve - EH433GT, GH433, 30:1 Pres
205-982	—	Available Only as 205-981 Intake Valve
206-199	—	Order as (1) each: 26-714 & 28-719
206-345	58-1584	Piston Valve - EH433GT, GH433, 30:1 Pres
206-399	58-1582	Intake Valve - EH333, 23:1 Monark
206-728	20-850	Kit - Fireball & Monark Air Motor
206-729	—	Replaced by 218-135 (20-1084)
206-733	20-380	Kit - 30:1 President, Viscount 3000
206-734	20-631	Kit - Bulldog Air Motor (7")
206-735	20-381	Kit - 30:1 Bulldog, GH533, 63:1 King
206-761	20-1626	Kit - 3:1 President
206-922	20-1050	Kit - 2:1 Monark
206-923	20-751	Kit - 5:1 Monark, 10:1 Pres, Viscount 1000
206-924	20-1047	Kit - 5:1 Fireball
206-926	20-1074	Kit - 5:1 Monark, 10:1 President
206-927	20-386	Kit - 9:1 & 10:1 President
206-935	—	Order as: (3) pc 207-839 (20-634)
206-939	20-384	Kit - Reverse-A-Clean (RAC)
207-084	—	Replaced by 223-603 (57-1402)
207-182	20-385	Kit - 1:1 Pump
207-240	14-370	Filter Bags - 12 Pack
207-241	14-700	Filter Assembly - For 3/4" Tube
207-308	20-990	Kit - HydraClean Valve
207-385	20-845	Kit - President Air Motor
207-386	20-1351	Kit - 15:1 President
207-472	58-1769	Piston Valve - 45:1 King, GH733, 20:1 Bull
207-473	58-2006	Intake Valve - 45:1 King, GH733, 20:1 Bull
207-580	20-606	Kit - 5:1 Monark, 10:1 President
207-581	20-999	Kit - 10:1 Bulldog (SS, Teflon)
207-729	20-983	Kit - 20:1 King, 10:1 Bull, GH833 HydraSpray
207-730	20-632	Kit - King Air Motor (10")
207-839	20-634	Kit - High Pressure Swivel (Leather)
207-846	20-387	Kit - 1:1 Solvent Fast-Flo
207-847	20-371	Kit - 1:1 Fast-Flo SS
207-849	—	Replaced by 218-136 (20-1114)
207-850	20-681	Kit - 28:1 & 30:1 President (Teflon)
207-851	20-643	Kit - 30:1 Bull, GH533, 63:1 King (Teflon)
207-884	20-1178	Kit - 5:1 Monark (Teflon)
207-917	20-1085	Kit - 5:1 Monark
207-949	20-1081	Kit - 10:1 President (Viton, SS)
207-966	20-855	Kit - 20:1 Bulldog, 45:1 King, GH733
208-178	20-821	Kit - 2:1 Standard Pump
208-238	20-840	Kit - SST Spray Guns
208-519	20-774	Kit - 5:1 Monark
208-520	20-607	Kit - 5:1 Monark Divorced
208-536	12-1330	Quick Disconnect Coupler 1/4" NPT(f)
208-919	20-389	Kit - EH433GT

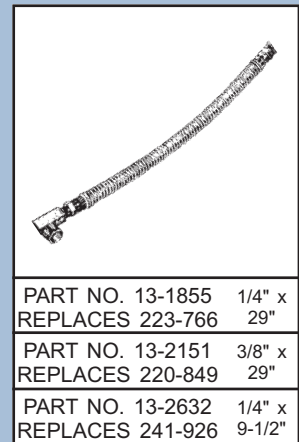
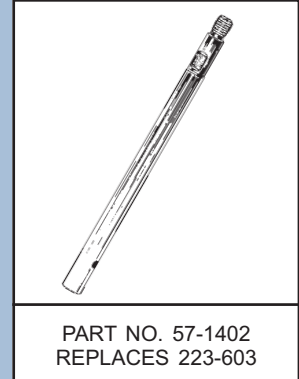

To order, contact your local
Paint Spray Equipment Dealer and ask for
Genuine Bedford Replacement Parts.

BEDFORD® Replacement Parts For . . . GRACO / ASM Equipment

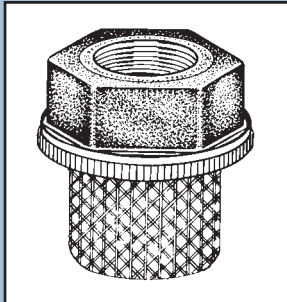

PART NO. 14-1964
REPLACES 235-004

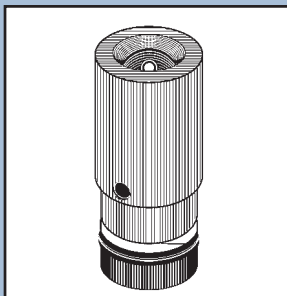

PART NO. 47-2370
REPLACES 235-009

REPLACES GRACO PART NO.	BEDFORD PART NO.	DESCRIPTION
208-940	20-379	Kit - EM400, EM480
210-041	—	Replaced by 223-589 (57-1404)
210-500	14-1200	Inline Filter Assy, 1/4" NPT(m) x 1/4" NPS(f)
210-501	12-1202	Housing
210-539	20-1268	Kit - 55:1 King, 20:1 Bulldog
210-540	—	Replaced by 223-540 (13-931)
210-541	—	Replaced by 223-541 (13-932)
210-657	29-1440	1/4" NPT x 1/4" NPT 5000 PSI Ball Valve
210-658	29-1441	3/8" NPT x 3/8" NPT 5000 PSI Ball Valve
210-659	29-1442	3/8" NPT x 1/4" NPT 5000 PSI Ball Valve
210-726	14-900	Filter Assembly - For 1-1/4" Tube
210-826	—	Replaced by 217-559 (20-1259)
210-866	13-366	15' x 5/16" Air Hose Assembly (Smooth)
210-867	13-354	25' x 5/16" Air Hose Assembly (Smooth)
210-868	13-355	50' x 5/16" Air Hose Assembly (Smooth)
212-058	—	Order (1) ea: 164-120, 205-264/5, 162-863
212-079	20-1269	Kit - 40:1 Bulldog, Polyurethane
213-012	20-1468	Kit - 1:1 Metric Fast-Flo (Leather)
213-013	20-1469	Kit - 1:1 Metric Fast-Flo (Teflon)
214-037	29-1443	1/4" NPT(mbe) Teflon 5000 PSI Ball Valve
214-570	14-1566	3000 PSI Fluid Outlet Filter Assembly
214-697	13-797	50' x 3/16" Airless Hose Assembly
214-698	13-796	25' x 3/16" Airless Hose Assembly
214-699	13-793	6' x 3/16" Airless Hose Assembly
214-700	13-791	2' x 3/16" Airless Hose Assembly
214-701	13-792	3' x 3/16" Airless Hose Assembly
214-703	13-451	25' x 3/8" Airless Hose Assembly
214-705	13-453	50' x 3/8" Airless Hose Assembly
214-730	20-1174	Kit - 2:1 Standard Pump
214-852	47-1662	Trip Rod Assy - Bulldog & King Air Motor
214-960	13-491	3-1/2' x 3/4" Suction Hose Assembly
214-961	13-492	6' x 3/4" Suction Hose Assembly
214-967	58-1430	Diffuser Seat Assembly - Silver/Flex Gun
214-981	13-795	15' x 3/16" Airless Hose Assembly
215-455	58-1585	Intake Valve - Ultra 400, EM380/390/490
215-496	20-1181	Kit - 45:1 King, GH733, 20:1 Bull (Teflon)
215-964	20-1470	Kit - 1:1 Metric Fast-Flo (Polyethylene)
217-474	—	Replaced by 207-851 (20-643)
217-475	—	Replaced by 206-735 (20-381)
217-476	58-2009	Intake Valve - 30:1 Bull, GH533, 63:1 King
217-541	—	Replaced by 223-589 (57-1404)
217-559	20-1259	Kit - Ball Valve, Viton Packed
217-560	20-1260	Kit - Ball Valve, Teflon Packed
217-574	58-1772	Intake Valve - Ultra 333/433/750/1000
218-017	—	Replaced by 222-438 (57-1910)
218-021	47-2062	Gun Swivel - Contractor Gun
218-023	58-1506	Diffuser Assembly - Contractor Gun
218-024	—	Replaced by Graco 238-169 (47-2261)
218-036	58-1775	Piston Valve - Ultra 333/433/1000, GM3500
218-070	20-1502	Kit - Contractor Gun
218-083	—	Replaced by 223-766 (13-1855)
218-122	20-1230	Kit - Senator Air Motor
218-129	58-1400	Needle Assembly - Silver/Flex Gun
218-131	14-1484	Gun Filter Assembly - 50 Mesh, Coarse
218-133	14-1485	Gun Filter Assembly - 100 Mesh, Fine

BEDFORD® Replacement Parts

For . . . GRACO / ASM Equipment

To order, contact your local
Paint Spray Equipment Dealer and ask for
Genuine Bedford Replacement Parts.

REPLACES GRACO PART NO.	BEDFORD PART NO.	DESCRIPTION
218-135	20-1084	Kit - 23:1 Monark, EH333, EH300
218-136	20-1114	Kit - 23:1 Monark, EH333 (Teflon)
218-143	20-1401	Kit - Silver Gun, Flex Gun
218-197	58-1461	Piston Valve - Ultra 400/600, EM380/390/490
218-559	20-1385	Kit - 15:1 President (Teflon)
218-578	—	Replaced by 218-083 (13-1304)
218-600	—	Order: (5) pcs 166-969 (8-173)
218-605	—	Replaced by 205-264 (14-151)
218-946	20-1488	Gun Adapter Kit
218-947	—	Order as: (1) pc 181-879 & (1) pc 218-197
218-948	—	Replaced by 222-587 (20-1526)
220-286	—	Replaced by 222-198 (29-1974)
220-366	—	Replaced by 222-588 (20-1499)
220-395	20-1355	Kit - 45:1 King, GH733, 20:1 Bulldog
220-396	20-1387	Kit - 15:1 President (SD)
220-397	—	Replaced by 223-675 (20-1898)
220-398	—	Replaced by 223-674 (20-1920)
220-399	20-1328	Kit - 30:1 Bulldog, GH533, 63:1 King
220-419	12-1314	Stop Bolt
220-629	58-1944	Intake Valve - GM5000/10000, Ultra 1500
220-630	57-1776	Rod - GM5000/10000, Ultra 1500
220-631	58-1938	Piston Valve - GM5000/10000, Ultra 1500
220-849	13-2151	Return Hose, 29"x3/8" - GM5000, Ultra 1500
220-877	20-1500	Kit - GM5000, Ultra 1500, GM10000
221-077	—	Order as: (1) pc 222-198 (29-1974)
221-098	58-2012	Intake Valve - Ultra 400, EM380/390/490
222-096	—	Replaced by 223-766 (13-1855)
222-198	29-1974	Drain Valve (Thumb Screw Type)
222-437	58-2014	Intake Valve - GM3500, EM590
222-438	57-1910	Rod - GM3500, Ultra 1000, EM590
222-587	20-1526	Kit - Ultra 400/500, EM380/390/490
222-588	20-1499	Kit - Ultra 333/433/1000, GM3500, EM590
223-341	12-1900	High Pressure Swivel, Teflon Packed
223-342	20-1935	Kit - Teflon Packed Swivel
223-365	20-1726	Packing Set - 45:1 King, GH733, 13:1 Senator
223-367	20-1727	Packing Set - 30:1 Bull, 63:1 King, GH533
223-371	—	Order as: (10) pcs 166-969 (8-173)
223-373	55-2451	Nylon Tip Washers (25), 1/16", Thin
223-374	55-2452	Nylon Tip Washers (25), 5/32", Thick
223-411	20-3018	Kit - Mark V, GM5000HD
223-540	13-931	25' x 1/4" Airless Hose Assembly
223-541	13-932	50' x 1/4" Airless Hose Assembly
223-560	58-3028	Piston Valve, SS - 45:1 King, GH733, 20:1 Bull
223-565	58-2306	Piston Valve (SS) - 30:1 President, GH433
223-589	57-1404	Rod - 30:1 Pres, EH433GT, GH433 (SD)
223-591	58-2307	Piston Valve (SS) - EH333, 23:1 Monark
223-593	—	Alternate P/N: 205-981 (58-1583)
223-603	57-1402	Rod - 23:1 Monark, EH333 (SD)
223-664	20-2434	Kit - EH433
223-674	20-1920	Kit - 23:1 Monark, EH333, EH300 (SD)
223-675	20-1898	Kit - 30:1 President, EH433GT, GH433 (SD)
223-766	13-1855	Hose Assy, 29" - EM490, Ultra 400/333
223-959	29-1791	3/8" NPT x 1/4" NPT Ball Valve (Teflon)
223-960	29-1504	3/8" NPT x 3/8" NPT Ball Valve (Teflon)
224-449	29-1440	1/4" NPT x 1/4" NPT 5000 PSI Ball Valve

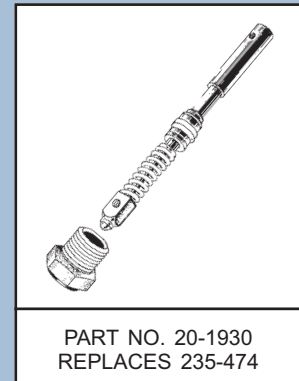
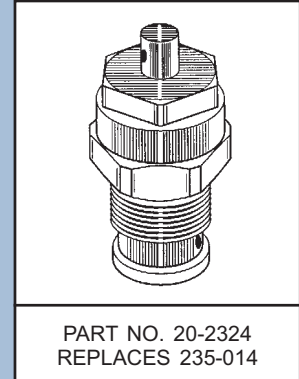

To order, contact your local
Paint Spray Equipment Dealer and ask for
Genuine Bedford Replacement Parts.

BEDFORD® Replacement Parts For . . . GRACO / ASM Equipment

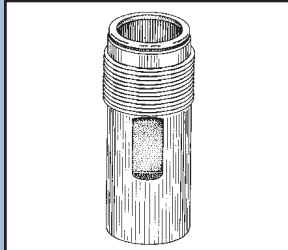

PART NO. 57-2099
REPLACES 235-708

PART NO. 57-2131
REPLACES 236-786



PART NO. 57-2672
REPLACES 240-517

PART NO. 57-2670
REPLACES 240-518

REPLACES GRACO PART NO.	BEDFORD PART NO.	DESCRIPTION
224-453	55-2454	Tip Filters (5), 100 Mesh, Fine, Enamel
224-454	55-2457	Tip Filters (5), 60 Mesh, Coarse, Latex
224-455	55-2483	Filter Elements (2), 50M, Contractor Gun
224-456	55-2484	Filter Elements (2), 100M, Contractor Gun
224-457	12-2485	1/4" Live Swivel, 3600 PSI, Leather Packed
224-458	55-2459	Strainers (2), Manifold Filter, 30 Mesh, Long
224-459	55-2462	Strainers (2), Manifold Filter, 60 Mesh, Long
224-468	55-2465	Strainers (2), Manifold Filter, 100 Mesh, Long
224-469	55-2468	Strainers (2), Manifold Filter, 200 Mesh, Long
224-771	20-2857	Seat Kit - PT2500, Pro201, FF-1000
224-775	29-2630	Drain Valve Housing & Stem Assembly
224-806	—	Replaced by 235-014 (20-2324)
224-808	58-2212	Piston Valve - 290 Easy, 390st, 390sts
224-966	58-2215	Intake Valve - 390st, 490st, Ultra 600
224-968	58-2323	Stem Assembly - Dump Valve
224-998	—	Replaced by 235-703 (20-1856)
235-004	14-1964	Inlet Filter, 3/4"UNF(f) 12 Mesh - 390st
235-009	47-2370	Kit - Pressure Transducer Assembly
235-014	20-2324	Kit - Bleed Valve
235-198	20-2078	Kit - Drain Valve
235-474	20-1930	Kit - Silver/Flex Gun Plus
235-557	—	Replaced by 218-197 (58-1461)
235-634	20-2932	Kit - 15:1 President (L/T)
235-635	20-2079	Kit - 30:1 President, GH433
235-636	20-2310	Kit - 23:1 Monark, EH333 (Leather/Teflon/SS)
235-703	20-1856	Kit - 390st, 395st, 490st, 495st, Ultra 600
235-708	57-2099	Cylinder - 395/490/495st, GM3000, Ultra 600
235-709	57-1946	Rod - 395st, 490st, 495st, Ultra 600
236-079	47-2631	Poppet Valve Assembly
236-495	55-2471	Outlet Filter (2-pack), 30 Mesh, Short
236-496	55-2474	Outlet Filters (2-pack), 60 Mesh, Short
236-497	55-2477	Outlet Filters (2-pack), 100 Mesh, Short
236-498	55-2480	Outlet Filters (2-pack), 200 Mesh, Short
236-564	20-2258	Kit - GM7000
236-565	58-2562	Piston Valve - GM7000
236-566	57-2381	Sleeve - GM7000
236-567	57-2440	Rod - GM7000
236-724	20-2311	Kit - 23:1 Monark, EH333 (Teflon/SS)
236-786	57-2131	Cylinder - 390st, 390sts
237-239	20-2294	Kit - DuraFlo 750, 33:1 Bull (Leather/Teflon)
237-241	20-2314	Kit - DuraFlo 750, 33:1 Bulldog (Teflon)
237-522	13-2556	6' x 1" ID Suction Hose Assy
237-677	—	Order: Repair Kit 235-014 (20-2324)
237-725	20-2799	Kit - 30:1 President (Teflon, SS)
238-117	20-3132	Kit - DuraFlo 750, 33:1 Bull (Leather/Teflon)
238-118	20-3133	Kit - DuraFlo 750, 33:1 Bull (Teflon)
238-169	47-2261	Ball Holder Assembly - Contractor Gun
238-286	20-2690	Kit - 5:1 Fireball
238-358	13-792	3' x 3/16" Airless Hose Assembly, 3300 PSI
238-359	13-793	6' x 3/16" Airless Hose Assembly, 3300 PSI
238-435	55-2460	Outlet Filters (3-pack), 30 Mesh, Long
238-436	55-2461	Outlet Filters (25-pack), 30 Mesh, Long
238-437	55-2463	Outlet Filters (3-pack), 60 Mesh, Long
238-438	55-2464	Outlet Filters (25-pack), 60 Mesh, Long
238-439	55-2466	Outlet Filters (3-pack), 100 Mesh, Long

BEDFORD® Replacement Parts

For . . . GRACO / ASM Equipment

To order, contact your local
Paint Spray Equipment Dealer and ask for
Genuine Bedford Replacement Parts.

REPLACES GRACO PART NO.	BEDFORD PART NO.	DESCRIPTION
238-440	55-2467	Outlet Filters (25-pack), 100 Mesh, Long
238-441	55-2469	Outlet Filters (3-pack), 200 Mesh, Long
238-442	55-2470	Outlet Filters (25-pack), 200 Mesh, Long
238-443	55-2472	Outlet Filters (3-pack), 30 Mesh, Short
238-444	55-2473	Outlet Filters (25-pack), 30 Mesh, Short
238-445	55-2475	Outlet Filters (3-pack), 60 Mesh, Short
238-446	55-2476	Outlet Filters (25-pack), 60 Mesh, Short
238-447	55-2478	Outlet Filters (3-pack), 100 Mesh, Short
238-448	55-2479	Outlet Filters (25-pack), 100 Mesh, Short
238-449	55-2481	Outlet Filters (3-pack), 200 Mesh, Short
238-450	55-2482	Outlet Filters (25-pack), 200 Mesh, Short
238-561	55-2453	Tip Filters (3-pack), 100 Mesh, Fine, Enamel
238-562	55-2455	Tip Filters (25-pack), 100 Mesh, Fine, Enamel
238-563	55-2456	Tip Filters (3-pack), 60 Mesh, Coarse, Latex
238-564	55-2458	Tip Filters (25-pack), 60 Mesh, Coarse, Latex
238-612	29-1441	3/8" NPT x 3/8" NPT 5000 PSI Ball Valve
238-635	29-1440	1/4" NPT(mbe) High Pressure Ball Valve
238-692	—	Replaced by 235-703 (20-1856)
238-769	14-2170	Filter Bags (25-pack)
239-328	20-3030	Kit - 23:1 Monark, EH333 (Leather/Teflon/SS)
239-663	12-2400	1/4" Live Swivel, 3600 PSI, Leather Packed
239-914	20-2806	Kit - Bleed Valve with Solv't Resistant O-Ring
239-922	20-2673	Intake Seat Kit - Seat (15/16"), Ball & O-Ring
239-928	—	Replaced by 248-212 (20-2662)
239-932	58-2564	Piston Valve - GMax 3900, UltraMax 795/1095
239-937	58-2990	Piston Valve Assy - UltraMax 695, 190ES
239-939	—	Replaced by 244-194 (20-2428)
240-150	58-2567	Piston Valve - GMax 5900/10000, Mark IV
240-248	—	Replaced by 248-213 (20-2663)
240-515	—	Replaced by 249-125 (57-3042)
240-516	—	Replaced by 243-177 (57-2831)
240-517	57-2672	Rod - UMax 1595, GMax 5900/10000
240-518	57-2670	Rod - UMax795/1095, UMax II 695/795
240-521	57-2273	Sleeve - Ultra Max 795/1095, GMax 3900
240-524	—	Replaced by 244-199 (20-2713)
240-525	57-2529	Sleeve - Gmax 5900, UltraMax 1595
240-580	58-2680	Piston Valve - GMax 7900
240-793	13-931	25' x 1/4" Airless Hose Assembly, 3300 PSI
240-794	13-932	50' x 1/4" Airless Hose Assembly, 3300 PSI
240-796	13-451	25' x 3/8" Airless Hose Assembly, 3300 PSI
240-797	13-453	50' x 3/8" Airless Hose Assembly, 3300 PSI
240-916	—	Replaced by 246-341 (20-2639)
240-918	20-2869	Inlet Seat - GH200/230/300, GMax 7900
240-919	57-2716	Rod - GMax 7900, GH 200, LL II/III/IV 200
240-921	57-2531	Sleeve - Gmax 7900, GMx 7900
241-926	13-2632	Hose Assembly - stPro, 190ES, 295st
243-055	—	Order as: 181-085 (12-1486)
243-070	14-2650	Outlet Filter, 30 Mesh - for Magnum Pumps
243-080	14-2685	Outlet Filter, 60 Mesh, Medium Length, Black
243-081	14-2686	Outlet Filter, 100 Mesh, Medium Length, Blue
243-082	14-2530	Inlet Strainer - 3/4" GH Thread
243-084	20-2719	Contractor Gun Filters, 50 & 100 Mesh (1 ea)
243-091	20-2359	Kit - 190ES
243-161	33-7000	Hand-Tight Reversible Tip Guard, 7/8" (G)
243-176	57-2775	Cylinder - 395/495 stPro, Ultra 695

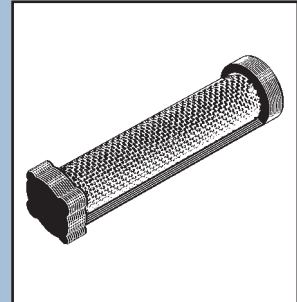

PART NO. 14-2650
REPLACES 243-070

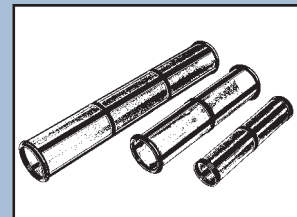

PART NO. 14-2675 60M
REPLACES 246-384 Short

PART NO. 14-2685 60M
REPLACES 243-080 Med

PART NO. 14-2695 60M
REPLACES 244-067 Long

To order, contact your local
Paint Spray Equipment Dealer and ask for
Genuine Bedford Replacement Parts.

BEDFORD® Replacement Parts For . . . GRACO / ASM Equipment

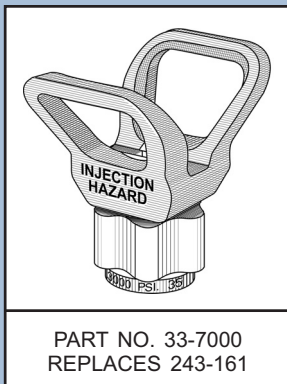
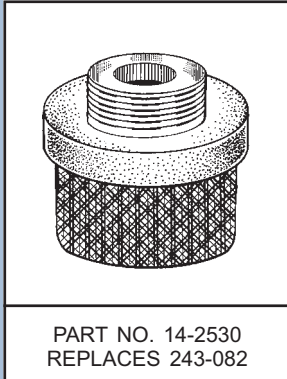

REPLACES GRACO PART NO.	BEDFORD PART NO.	DESCRIPTION
243-177	57-2831	Cylinder - UltraMax 695, Ultimate Mx 695
243-178	—	Replaced by 249-125 (57-3042)
243-181	58-2570	Piston Valve - UltraMax 695
243-190	20-2561	Intake Valve - 395/455/495stPro, UMax 695
243-192	—	Replaced by 244-194 (20-2428)
243-226	14-2687	Outlet Filter, 200 Mesh, Medium Length, Red
243-263	33-7002	Hand-Tight Reversible Tip Guard, 11/16" (F)
243-281	33-7001	Reversible Tip Seat & Seal, 5-Pack
243-954	13-796	25' x 3/16" Airless Hose Assembly
243-984	14-2795	Outlet Filter, 60 Mesh, Long, Black
244-065	14-2796	Outlet Filter, 100 Mesh, Long, Blue
244-066	14-2797	Outlet Filter, 200 Mesh, Long, Red
244-067	14-2695	Outlet Filter, 60 Mesh, Long, Black
244-068	14-2696	Outlet Filter, 100 Mesh, Long, Blue
244-069	14-2697	Outlet Filter, 200 Mesh, Long, Red
244-070	14-2794	Outlet Filter, 30 Mesh, Long, Gray
244-071	14-2694	Outlet Filter, 30 Mesh, Long, Gray
244-194	20-2428	Kit - 295st, 390, 395/495st Pro, Ult 395/495
244-196	—	Replaced by 248-212 (20-2662)
244-198	—	Replaced by 248-213 (20-2663)
244-199	20-2713	Intake Seat (1-1/4") - Seat, Ball & O-Ring
244-200	20-3181	Kit - Mark V
244-216	—	Order as: 240-518 (57-2670)
244-217	—	Order as: 240-517 (57-2672)
244-515	—	Order as: 239-663 (12-2400)
244-782	—	Replaced by 244-783 (13-2543)
244-850	20-2947	Kit - 145cc Xtreme 600
244-851	20-2938	Kit - 180cc Xtreme 750
244-852	20-2961	Kit - 220cc Xtreme 900
244-853	—	Replaced by 24F-965 (20-3047)
244-858(1)	2-3039	Tuff-type V-Packing (1 pc, order per packing)
244-863(1)	49-2943	Polyethylene V-Pkg (1 pc, order per packing)
244-864(1)	49-2937	Polyethylene V-Pkg (1 pc, order per packing)
244-865(1)	49-2960	Polyethylene V-Pkg (1 pc, order per packing)
244-866(1)	49-2955	Polyethylene V-Pkg (1 pc, order per packing)
244-869(1)	1-2942	Leather V-Pkg (1 pc, order per packing)
244-870(1)	1-2934	Leather V-Pkg (1 pc, order per packing)
244-871(1)	1-2959	Leather V-Pkg (1 pc, order per packing)
244-872(1)	1-2956	Leather V-Pkg (1 pc, order per packing)
244-875(1)	18-2941	Female Gland (1 pc, order per gland)
244-876(1)	18-2936	Female Gland (1 pc, order per gland)
244-877(1)	18-2957	Female Gland (1 pc, order per gland)
244-878(1)	18-2953	Female Gland (1 pc, order per gland)
244-881(1)	18-2940	Male Gland (1 pc, order per gland)
244-882(1)	18-2935	Male Gland (1 pc, order per gland)
244-883(1)	18-2958	Male Gland (1 pc, order per gland)
244-884(1)	18-2954	Male Gland (1 pc, order per gland)
244-890	55-2641	Teflon O-Rings (10-pack)
244-891	55-2966	Teflon O-Rings (10-Pack)
244-892	55-2647	Teflon O-Rings (10-pack)
244-893	55-2645	Teflon O-Rings (10-pack)
244-894	55-2643	Teflon O-Rings (10-pack)
244-895	55-2536	Teflon O-Rings (10-pack)
244-896	55-2537	Teflon O-Rings (10-pack)
244-898(1)	9-2948	Ball (1 pc, order per ball)

BEDFORD® Replacement Parts

For . . . GRACO / ASM Equipment

To order, contact your local
Paint Spray Equipment Dealer and ask for
Genuine Bedford Replacement Parts.

REPLACES GRACO PART NO.	BEDFORD PART NO.	DESCRIPTION
244-955	—	Replaced by 246-341 (20-2639)
244-996(1)	17-2945	Plug, 1-3/4" (1 pc, order per plug)
244-999(1)	17-2951	Plug, 2" (1 pc, order per plug)
245-128(1)	9-2963	Ball (1 pc, order per ball)
245-143	29-3150	Bleed Valve - Xtreme Lowers, ProMix
245-145	20-3014	Kit - Sampling/Dump Valve
245-229(1)	2-3043	V-Packing (1 pc, order per packing)
245-230(1)	1-3044	Leather V-Packing (1 pc, order per packing)
245-231(1)	49-3045	Polyethylene V-Pkg (1 pc, order per packing)
245-232(1)	18-3046	Male Gland (1 pc, order per gland)
245-414	—	Order as: 240-919 (57-2716)
245-525	20-2781	Kit - 1900
245-526	14-2787	Outlet Filter, 200 Mesh, Medium-Length, Red
245-527	14-2785	Outlet Filter, 60 Mesh, Medium-Length, Black
245-528	14-2786	Outlet Filter, 100 Mesh, Medium-Length, Blue
245-578	14-2760	Inlet Strainer, 3/4" GH Thread
245-673	14-3054	Inlet Filter, 3/4"-16 UNF(f) 12 Mesh
245-797	13-3226	Hose Assembly, 3/8" x 3' (fbe) - LineLazer
245-798	13-3180	Hose Assy, 1/4" x 7' (fbe) - LineLazer
245-819	20-3184	Kit - Mark V SpackMax
246-341	20-2639	Kit - GH200, GMax 7900, HydraMax 225
246-351	20-2904	O-Ring Kit - Check Valve
246-354	55-2890	O-Rings, Solvent Resistant (6-Pack)
246-355	20-2905	O-Ring Kit - AP Gun
246-357	55-3024	Filters, 40 Mesh - Fusion Guns (10-pack)
246-358	55-3025	Filters, 60 Mesh - Fusion Guns (10-pack)
246-359	55-3026	Filters, 80 Mesh - Fusion Guns (10-pack)
246-360	55-2919	Teflon O-Rings, Flat Tip (3-Pack)
246-382	14-2676	Outlet Filter, 100 Mesh, Short, Blue
246-384	14-2675	Outlet Filter, 60 Mesh, Short, Black
246-385	14-2649	Inlet Strainer, 7/8" UNF Thd - Ultra 395/495
246-423	—	Replaced by 249-125 (57-3042)
246-429	20-2757	Intake Seat Kit - 395/495 stPro, Ultra 695
246-530(1)	18-3041	Female Gland (1 pc, order per gland)
247-394(1)	17-2944	Plug, 2-1/2" (1 pc, order per plug)
247-395(1)	17-2950	Plug, 2-1/2" (1 pc, order per plug)
248-000	20-2906	O-Ring Kit - MP Gun
248-095	55-2891	O-Rings, Solvent Resistant (6-Pack)
248-096	55-2892	O-Rings, Solvent Resistant (6-Pack)
248-128	55-2893	O-Rings, Solvent Resistant (6-Pack)
248-129	55-2894	O-Rings, Solvent Resistant (6-Pack)
248-130	55-2895	O-Rings, Solvent Resistant (6-Pack)
248-131	55-2896	O-Rings, Solvent Resistant (6-Pack)
248-132	55-2897	O-Rings, Solvent Resistant (6-Pack)
248-133	55-2898	O-Rings, Solvent Resistant (6-Pack)
248-134	55-2899	O-Rings, Solvent Resistant (6-Pack)
248-135	55-2900	O-Rings, Solvent Resistant (6-Pack)
248-136	55-2901	O-Rings, Solvent Resistant (6-Pack)
248-137	55-2902	Teflon O-Rings (6-Pack)
248-138	55-2903	O-Rings, Solvent Resistant (6-Pack)
248-206	—	Order as: 240-518 (57-2670)
248-207	—	Order as: 240-517 (57-2672)
248-209	—	Order as: 240-521 (57-2273)
248-210	—	Order as: 240-525 (57-2529)
248-212	20-2662	Kit - UltraMax II 695/795, GMax II 3900

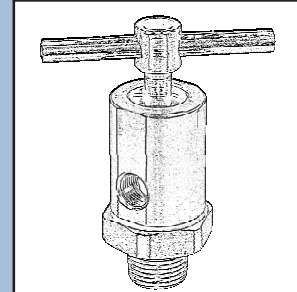

PART NO. 29-3150
REPLACES 245-143

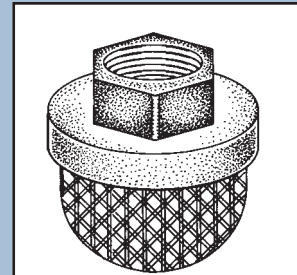

PART NO. 14-2649
REPLACES 246-385

To order, contact your local
Paint Spray Equipment Dealer and ask for
Genuine Bedford Replacement Parts.

BEDFORD® Replacement Parts For . . . GRACO / ASM Equipment

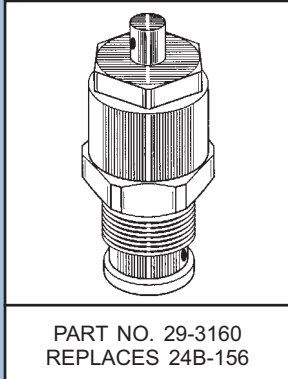

PART NO. 29-3160
REPLACES 24B-156

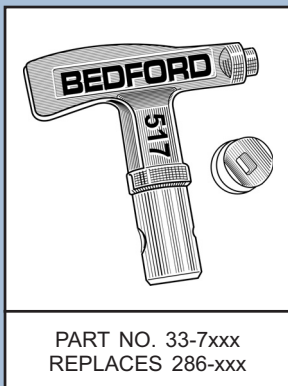

PART NO. 33-7xxx
REPLACES 286-xxx

REPLACES GRACO PART NO.	BEDFORD PART NO.	DESCRIPTION
248-213 248-502 248-648 248-979 248-980	20-2663 — 55-3114 — 57-3185	Kit - UMax II 1095/1595, GMax II 5900/10000 Order as: 239-932 (58-2564) O-Rings, Solvent Resistant (6-Pack) Order as: 240-921 (57-2531) Sleeve - GH230, GH300 (Alt for 287-817)
249-000 249-028 249-119 249-121 249-123	— 57-3072 — — 20-2917	Order as: 240-919 (57-2716) Rod - Mk V, GMax 5900HD, IronMan 300E/500G Order as: 240-919 (57-2716) Order as: 240-921 (57-2531) Kit - GMax II 7900, UltraMax II 1895, Mark X
249-125 249-177 249-189 249-197 249-198	57-3042 58-3182 20-3128 14-1484 14-1485	Rod, Valve, Pin - 190ES, 390, UltraMax 695 Piston Valve - GMax II 7900, GH 200/230/300 Kit - GH130, 5900HD, Ultra 1095/1595 Gun Filter Assembly - 50 Mesh, Coarse Gun Filter Assembly - 100 Mesh, Fine
249-199 249-200 24A-381 24B-156 24B-732	14-2664 14-2665 — 29-3160 55-2965	Gun Filter, 60 Mesh - Contractor II / FTxII Gun Filter, 100 Mesh - Contractor II / FTxII Replaced by 24B-156 (29-3160) Prime Valve HD - Ultra & UltraMax, Mark IV/V/X O-Rings, Solvent Resistant (10-Pack)
24B-733 24C-499 24C-508 24E-376 24F-039	55-2931 — — 14-3222 55-3224	O-Rings, Solvent Resistant (10-Pack) Order as: Graco 178-898 (57-1403) Order as: 223-603 (57-1402) Filter, 60 Mesh - ProShot, TrueCoat Filters, 60 Mesh (3-Pack) - ProShot, TrueCoat
24F-640 24F-641 24F-965 24F-966 24F-967	14-3221 55-3223 20-3047 20-3048 20-3009	Filter, 100 Mesh - ProShot, TrueCoat Filters, 100 Mesh (3-Pk) - ProShot, TrueCoat Kit - 250cc Xtreme 1045 with Xtreme-type Pkgs Kit - 250cc Xtreme 1045 with Tuff-type Pkgs Kit - 220cc Xtreme 900
24F-969 24F-970 24F-971 24M-570 24N-012	20-3010 20-3049 20-3011 — 20-3194	Kit - 180cc Xtreme 750 Kit - 180cc Xtreme 750 Tuff-type Stack Kit - 145cc Xtreme 600 Order as: (100) pcs 184-303 (1-2290) Kit - EH/GH 200DI, DutyMax EH/GH 230/300
24U-993 24V-063 24X-096 253-029(1) 253-030(1)	58-3179 20-3195 20-3196 9-2964 9-2952	Piston Valve - GMax 5900/10000, Mark IV Kit - Mark IV, TexSpray Mark IV Kit - GH230/300, EH230/300, DutyMax DH230 Ball (1 pc, order per ball) Ball (1 pc, order per ball)
255-204 256-467 256-468 256-469 256-470	20-2858 55-3115 55-3116 55-3117 20-3118	Kit - 190ES, 190LTS, 210ES, 210LTS O-Rings, Solvent Resistant (6-Pack) O-Rings, Solvent Resistant (6-Pack) O-Rings, Solvent Resistant (6-Pack) O-Ring Kit, Solvent Resistant
256-471 256-640 256-771 256-772 256-773	20-3119 20-3120 55-3121 55-3122 55-3123	O-Ring Kit, Solvent Resistant O-Ring Kit, Solv Res - Fusion CS Head Check V O-Rings, Solvent Resistant (6-Pack) O-Rings, Solvent Resistant (6-Pack) O-Rings, Solvent Resistant (6-Pack)
256-774 256-775 257-001 257-002 257-003	55-3124 55-3125 14-3001 14-3002 14-3003	O-Rings, Solvent Resistant (6-Pack) O-Rings, Solvent Resistant (6-Pack) Outlet Strainer Inlet Strainer, 3/4"GH(m) Thread Inlet Strainer, 3/4"(f) UNF Thread

BEDFORD® Replacement Parts

For . . . GRACO / ASM Equipment

To order, contact your local
Paint Spray Equipment Dealer and ask for
Genuine Bedford Replacement Parts.

REPLACES GRACO PART NO.	BEDFORD PART NO.	DESCRIPTION
257-129	14-3225	Gun Filter, 30 Mesh - Contractor II / FTxII
257-566	14-3211	Inlet Strainer - 3/4"GH(m) Thread, 16 Mesh
25M-239	55-3201	O-Rings, Solv Resistant, 50-Pk (256-467/246-354)
25M-240	55-3202	O-Rings, Solvent Resistant, 50-Pack (248-648)
25M-241	55-3203	O-Rings, Solvent Resistant, 50-Pack (248-648)
25M-242	55-3204	O-Rings, Solvent Resistant, 50-Pack (248-130)
25M-243	55-3205	O-Rings, Solvent Resistant, 50-Pack (248-131)
25M-244	55-3206	O-Rings, Teflon, 50-Pack (248-137)
25M-245	55-3207	O-Rings, Solvent Resistant, 25-Pack (248-135)
25M-247	55-3208	O-Rings, Solvent Resistant, 25-Pack (248-129)
25M-248	55-3209	O-Rings, Teflon, 25-Pack (246-360)
25M-249	55-3210	O-Rings, Solvent Resistant, 25-Pack (256-771)
262-483	55-3005	Teflon O-Rings (10-Pack)
262-484	55-3008	Teflon O-Rings (10-Pack)
262-792	20-3050	Kit - 180cc Xtreme 750 X-Tuff-type Stack
262-794	20-3051	Kit - 250cc Xtreme 1045 with X-Tuff-type Pkgs
276-897	14-2759	Inlet Strainer, 7/8" UNF Thread
277-241	13-932	50' x 1/4" Airless Hose Assy, 3300 PSI
277-242	13-453	50' x 3/8" Airless Hose Assy, 3300 PSI
277-364	20-2865	Gasket Kit
286-207	33-7207	Reversible Tip - .007" Orifice, 4"-6" Fan
286-209	33-7209	Reversible Tip - .009" Orifice, 4"-6" Fan
286-211	33-7211	Reversible Tip - .011" Orifice, 4"-6" Fan
286-213	33-7213	Reversible Tip - .013" Orifice, 4"-6" Fan
286-215	33-7215	Reversible Tip - .015" Orifice, 4"-6" Fan
286-217	33-7217	Reversible Tip - .017" Orifice, 4"-6" Fan
286-219	33-7219	Reversible Tip - .019" Orifice, 4"-6" Fan
286-309	33-7309	Reversible Tip - .009" Orifice, 6"-8" Fan
286-311	33-7311	Reversible Tip - .011" Orifice, 6"-8" Fan
286-313	33-7313	Reversible Tip - .013" Orifice, 6"-8" Fan
286-315	33-7315	Reversible Tip - .015" Orifice, 6"-8" Fan
286-317	33-7317	Reversible Tip - .017" Orifice, 6"-8" Fan
286-319	33-7319	Reversible Tip - .019" Orifice, 6"-8" Fan
286-321	33-7321	Reversible Tip - .021" Orifice, 6"-8" Fan
286-323	33-7323	Reversible Tip - .023" Orifice, 6"-8" Fan
286-325	33-7325	Reversible Tip - .025" Orifice, 6"-8" Fan
286-327	33-7327	Reversible Tip - .027" Orifice, 6"-8" Fan
286-411	33-7411	Reversible Tip - .011" Orifice, 8"-10" Fan
286-413	33-7413	Reversible Tip - .013" Orifice, 8"-10" Fan
286-415	33-7415	Reversible Tip - .015" Orifice, 8"-10" Fan
286-417	33-7417	Reversible Tip - .017" Orifice, 8"-10" Fan
286-419	33-7419	Reversible Tip - .019" Orifice, 8"-10" Fan
286-421	33-7421	Reversible Tip - .021" Orifice, 8"-10" Fan
286-423	33-7423	Reversible Tip - .023" Orifice, 8"-10" Fan
286-425	33-7425	Reversible Tip - .025" Orifice, 8"-10" Fan
286-427	33-7427	Reversible Tip - .027" Orifice, 8"-10" Fan
286-429	33-7429	Reversible Tip - .029" Orifice, 8"-10" Fan
286-431	33-7431	Reversible Tip - .031" Orifice, 8"-10" Fan
286-435	33-7435	Reversible Tip - .035" Orifice, 8"-10" Fan
286-511	33-7511	Reversible Tip - .011" Orifice, 10"-12" Fan
286-513	33-7513	Reversible Tip - .013" Orifice, 10"-12" Fan
286-515	33-7515	Reversible Tip - .015" Orifice, 10"-12" Fan
286-517	33-7517	Reversible Tip - .017" Orifice, 10"-12" Fan
286-519	33-7519	Reversible Tip - .019" Orifice, 10"-12" Fan
286-521	33-7521	Reversible Tip - .021" Orifice, 10"-12" Fan

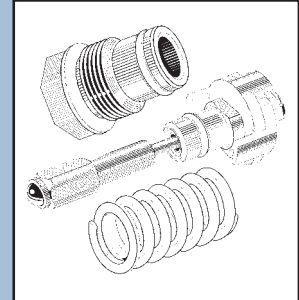

PART NO. 20-2701
REPLACES 287-031



PART NO. 14-2664 60M
REPLACES 287-032

PART NO. 14-2665 100M
REPLACES 287-033

To order, contact your local
Paint Spray Equipment Dealer and ask for
Genuine Bedford Replacement Parts.

BEDFORD® Replacement Parts For . . . GRACO / ASM Equipment

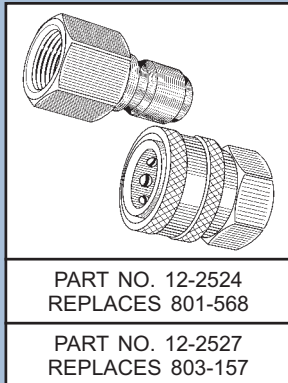

REPLACES GRACO PART NO.	BEDFORD PART NO.	DESCRIPTION
286-523	33-7523	Reversible Tip - .023" Orifice, 10"-12" Fan
286-525	33-7525	Reversible Tip - .025" Orifice, 10"-12" Fan
286-527	33-7527	Reversible Tip - .027" Orifice, 10"-12" Fan
286-529	33-7529	Reversible Tip - .029" Orifice, 10"-12" Fan
286-531	33-7531	Reversible Tip - .031" Orifice, 10"-12" Fan
286-535	33-7535	Reversible Tip - .035" Orifice, 10"-12" Fan
286-615	33-7615	Reversible Tip - .015" Orifice, 12"-14" Fan
286-617	33-7617	Reversible Tip - .017" Orifice, 12"-14" Fan
286-619	33-7619	Reversible Tip - .019" Orifice, 12"-14" Fan
286-621	33-7621	Reversible Tip - .021" Orifice, 12"-14" Fan
286-623	33-7623	Reversible Tip - .023" Orifice, 12"-14" Fan
286-625	33-7625	Reversible Tip - .025" Orifice, 12"-14" Fan
286-627	33-7627	Reversible Tip - .027" Orifice, 12"-14" Fan
286-629	33-7629	Reversible Tip - .029" Orifice, 12"-14" Fan
286-631	33-7631	Reversible Tip - .031" Orifice, 12"-14" Fan
286-633	33-7633	Reversible Tip - .033" Orifice, 12"-14" Fan
286-635	33-7635	Reversible Tip - .035" Orifice, 12"-14" Fan
286-717	33-7717	Reversible Tip - .017" Orifice, 14"-16" Fan
286-721	33-7721	Reversible Tip - .021" Orifice, 14"-16" Fan
286-723	33-7723	Reversible Tip - .023" Orifice, 14"-16" Fan
286-725	33-7725	Reversible Tip - .025" Orifice, 14"-16" Fan
286-819	33-7819	Reversible Tip - .019" Orifice, 16"-18" Fan
287-031	20-2701	Kit - Contractor II & FTx II Spray Guns
287-032	14-2664	Gun Filter, 60 Mesh - Contractor II / FTxII
287-033	14-2665	Gun Filter, 100 Mesh - Contractor II / FTxII
287-034	14-2648	Gun Filters, 60 & 100 Mesh - Contractor II
287-078	20-3031	Kit, with Piston Valve and Nut - 190ES
287-079	—	Order as (1) ea: 222-588, 218-036, 178-945
287-545	20-3136	Pressure Relief Valve - FieldLazer/TurfLazer
287-813	20-2914	Kit - EH200, GH200, GH230, GH300
287-817	—	Order as: 248-980 (57-3185)
287-825	20-2774	Kit - Mark IV
287-835	20-3146	Kit - GH833
287-877	58-3178	Piston Valve - GMax 3900, UltraMax 795/1095
287-945	20-3016	Kit - Mark X
288-067	55-3069	Teflon O-Rings (10-Pack)
288-068	55-3071	Teflon O-Rings (10-Pack)
288-471	20-3034	Kit - GH130, LineLazer 130HS
288-472	14-3134	Inlet Filter, 10 Mesh - GH130, GH230, GH300
288-716	14-2843	Inlet Strainer - 3/4"GH(m) Thread, 32 Mesh
288-747	14-2829	Outlet Filter, 40 Mesh
331-308	18-2277	Female Adapter, double sided
556-562	0-1827	O-Ring
801-568	12-2524	3/8" NPT(f) Quick Disc Plug, Stainless Steel
801-569	12-2526	3/8" NPT(f) Quick Disconnect Coupler, Brass
803-157	12-2527	3/8" NPT(f) Quick Disc Coupler, Stainless St
865-671	20-1816	Kit - 8100, 9100 Pumps
865-672	20-1815	Kit - 3600, 4100, 5100, 5300, 6100 Pumps
866-017	18-1835	Female Adapter
866-018	18-2409	Male Adapter
866-100	18-2308	Female Gland
866-154	12-2025	Guide
866-328	15-1839	Teflon O-Ring
866-429	58-2024	Ball Holder Assembly - 007 Gun
866-432	58-2022	Diffuser/Valve Seat Assembly - 007 Gun

BEDFORD® Replacement Parts

For . . . GRACO / ASM Equipment

To order, contact your local
Paint Spray Equipment Dealer and ask for
Genuine Bedford Replacement Parts.

REPLACES GRACO PART NO.	BEDFORD PART NO.	DESCRIPTION
867-032	18-2028	Male Adapter
867-033	18-2030	Female Adapter
867-044	9-1818	Ball, 7/32", Carbide
867-047	9-1819	Ball, 5/16", Carbide
867-049	9-1820	Ball, 11/32", Carbide
867-051	9-1822	Ball
867-053	9-1841	Ball
867-320	19-2007	Locknut
867-356	15-2406	Teflon O-Ring
867-358	15-1832	Teflon O-Ring
867-359	0-1833	O-Ring
867-361	15-1998	Teflon O-Ring
867-362	15-1990	Teflon O-Ring
867-370	15-2052	Teflon O-Ring
867-371	15-1840	Teflon O-Ring
867-372	15-1826	Teflon O-Ring
867-373	0-1827	O-Ring
867-377	15-3070	Teflon O-Ring
867-378	15-1824	Teflon O-Ring
867-379	0-1825	O-Ring
867-389	15-1838	Teflon O-Ring
867-390	15-1834	Teflon O-Ring
867-561	2-2029	Teflon Seal
867-564	6-1821	Piston Seal
867-570	58-2239	Carbide Ball Seat
867-598	44-2027	Shaft
867-608	49-2408	V-Packing
867-628	23-2026	Spring
867-688	1-1830	Leather V-Packing
867-689	1-1828	Leather V-Packing
867-691	1-1836	Leather V-Packing
867-692	2-1837	Teflon V-Packing
867-693	49-2407	V-Packing
867-711	17-1894	Ball Stop
867-712	8-2018	Tip Washer
948-336	20-3096	Kit - 1:1 Mix-Ratio Hydra-Cat President
C20-207	0-3086	O-Ring
C20-987	0-3113	O-Ring
C20-988	0-3063	O-Ring
C38-225	0-3095	O-Ring
GC1-931	0-3080	O-Ring, Solvent Resistant
GC1-932	0-3081	O-Ring, Solvent Resistant
GC1-933	0-3082	O-Ring, Solvent Resistant
GC1-934	0-3083	O-Ring, Solvent Resistant
GC1-935	0-3084	O-Ring, Solvent Resistant
GC1-936	0-3085	O-Ring, Solvent Resistant
GC1-937	20-3087	Kit - Probler P2 Gun, "Standard" O-Ring Kit
GC1-950	20-3088	Kit - Probler P2 Gun, "Premium" O-Ring Kit
GC2-056	0-3076	O-Ring
GC2-057	0-3060	O-Ring
GC2-058	0-3077	O-Ring
GC2-059	0-3078	O-Ring
GC2-060	0-3079	O-Ring

To order, contact your local
Paint Spray Equipment Dealer and ask for
Genuine Bedford Replacement Parts.

BEDFORD® Replacement Parts For . . . H.E.R.O. Equipment

Quick Reference for . . . H.E.R.O. Pumps

PUMP MODEL	For the Bedford Replacement Part, refer to the following H.E.R.O. component P/N's:									
	DIAPHRAGM ASSEMBLY	INTAKE REPAIR PARTS					OUTGO REPAIR PARTS			
		HEAD & SEAT ASSEMBLY	INTAKE REPAIR KIT	SEAT	BALL	CAGE	OUTGO REPAIR KIT	SEAT	BALL	CAGE
75, 75W, 80, 90, 300GS/S/SL, 2000, 3000 Diaphragm Pumps	4-22C	4-4B	4-6652	6	17S 17	4-183S 18A	4-6655	11A-45 11A-4	11A-5S 11A-5	11A-6
1150G, 1150GS Diaphragm Pumps	4-622C	—	4-6653	6	17S	4-183S	4-6656 (See Note)	11A-45	11A-5S	11A-6
1000NC, 1100C, 1100NC Diaphragm Pumps	4-22C	4-4B	4-6651	6	17S 17	4-183S 18A	4-6655	11A-45 11A-4	11A-5S 11A-5	11A-6

Note: When ordering 4-6656 "Outgo Repair Kit", order 11A-45 "Outgo Seat" separately.

PUMP MODEL	Complete Fluid Section Repack / Repair Kits		
	REPLACES H.E.R.O. PART NO.	BEDFORD PART NO.	CONTAINS THE FOLLOWING ITEMS:
75, 75W, 80, 90, 300S, 300SL, 300GS 2000, 3000 Diaphragm Pumps	4-10-22-1502	20-1932	5 Intake O-Ring 17S Corrosion Resistant Intake Ball 4-22CRK Diaphragm Repair Kit 7C Outgo Valve Washer 11A-3CP Outgo Seat Crush Washer 11A-5 Nylon Outgo Ball
1150G, 1150GS Diaphragm Pumps	4-10-22-1507	20-1934	5 Intake O-Ring 17S Corrosion Resistant Intake Ball 4-622CRK Diaphragm Repair Kit 7C Outgo Valve Washer 11A-3CP Outgo Seat Crush Washer 11A-5S Corrosion Resistant Outgo Ball
1000NC, 1100C, 1100NC Diaphragm Pumps	4-10-22-1503	20-1933	5 Intake O-Ring 17 Nylon Intake Ball 4-22CRK Diaphragm Repair Kit 7C Outgo Valve Washer 11A-3CP Outgo Seat Crush Washer 11A-5 Nylon Outgo Ball
400, 401, 500, 501, 6000 Piston Pumps	4-02-40-2510	20-2051	02-40-2003 Intake Valve O-Ring 02-40-2004 Lower Ball (Intake) 02-40-2007 Crush Washer 02-40-2010 Backup Washer 02-40-2018 Upper Ball (Piston) 4-02-40-2503 Upper Packing Set 4-02-40-2509 Lower packing Set

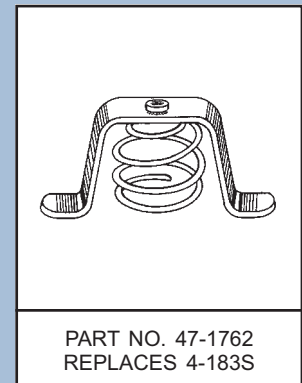
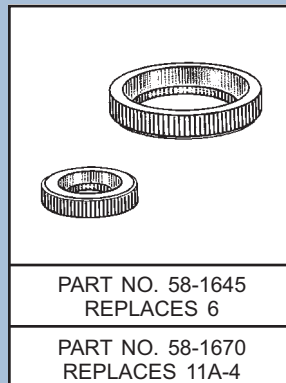
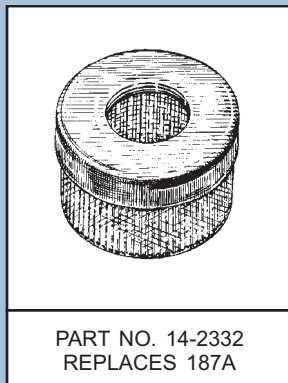

BEDFORD® Replacement Parts

For . . . H.E.R.O. Equipment

To order, contact your local
Paint Spray Equipment Dealer and ask for
Genuine Bedford Replacement Parts.

REPLACES H.E.R.O. PART NO.	BEDFORD PART NO.	DESCRIPTION
1-3-WHIP	—	Replaced by 3-WHIPEND (13-792)
02-22-2006	0-2003	Intake O-Ring, Urethane
02-22-2007	0-2004	Intake O-Ring, Viton
02-22-2009	10-2005	Intake Washer, Crush
02-40-2003	15-2033	Intake Valve O-Ring, Teflon
02-40-2004	9-2034	Ball, Intake Valve
02-40-2007	10-2035	Intake Washer, Crush
02-40-2010	10-2036	Backup Washer, Piston Valve
02-40-2018	9-2037	Ball, Piston Valve
02-40-2019	57-2334	Rod - 400, 500, 6000 Pumps
3-WHIPEND	13-792	3' x 3/16" Airless Hose Assembly
4-02-40-2019	—	Order as: (1) 02-40-2019 (57-2334)
4-02-40-2503	20-2038	Upper Packing Set - 400, 500, 6000
4-02-40-2509	20-2044	Lower Packing Set - 400, 500, 6000
4-02-40-2510	20-2051	Kit - 400, 500, 6000 Series Pumps
4-10-22-1502	20-1932	Kit - 75W, 80, 90, 300S/SL, 2000
4-10-22-1503	20-1933	Kit - 1100NC, 1000NC
4-10-22-1507	20-1934	Kit - 1150G, 1150GS
4-4B	47-1953	Intake Head Assembly (SS) - for 3/8" bolts
4-22C	20-1725	Diaphragm Assembly - Electric Models
4-22CRK	20-1632	Kit - Diaphragm Repair, Electric Models
4-183S	47-1762	Intake Ball Cage, Spring Loaded
4-606RK	20-2538	Kit - Prime/Bleed Valve
4-622C	20-1888	Diaphragm Assembly - Gas Models
4-622CRK	20-1889	Kit - Diaphragm Repair - Gas Models
4-6650	20-1722	Kit - Intake Repair
4-6651	20-1729	Kit - Intake Overhaul
4-6652	20-1763	Kit - Intake Repair
4-6653	20-1764	Kit - Intake Overhaul
4-6654	20-1723	Kit - Outgo Repair
4-6655	20-1724	Kit - Outgo Overhaul
4-6656	20-1721	Kit - Outgo Repair
5	0-1588	O-Ring
5V	0-1589	Intake O-Ring, Viton
6	58-1645	Seat, Intake Valve, 3/4"
7C	10-1590	Washer, Outgo Valve, Copper
10-55-4404	47-2227	Ball & Plunger Assembly, ASM 400 Gun
10-55-4405	47-2229	Ball Holder Assembly, ASM 400 Gun
10-55-4412	6-2223	External Seal, ASM 400 Gun
10-55-4425	55-2226	Valve Stem Locknut (3-pack), ASM 400 Gun
10-55-4428	47-2235	Plunger Assembly, ASM 400 Gun
11A-3CP	10-1591	Washer, Outgo, Copper, Crush
11A-4	58-1670	Seat, Outgo Valve, 3/8"
11A-5	9-1592	Ball, Outgo, Nylon, 3/8"
11A-5S	9-1593	Ball, Outgo, 3/8" Corrosion Resistant
11A-6	17-1705	Cage, Outgo Ball
11A-7	23-1600	Spring, Outgo Valve
11A-45	58-1740	Seat, Outgo Valve (90°)
17	9-1594	Ball, Intake, Nylon, 3/4"
17S	9-1595	Ball, Intake, 3/4" Corrosion Resistant

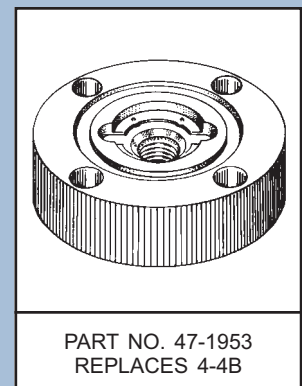
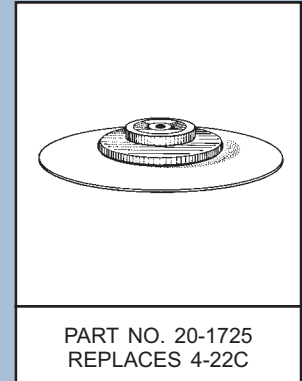

To order, contact your local
Paint Spray Equipment Dealer and ask for
Genuine Bedford Replacement Parts.

BEDFORD® Replacement Parts For . . . H.E.R.O. Equipment

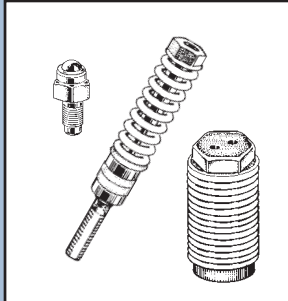

PART NO. 20-2032
REPLACES A7-120-3-007

REPLACES H.E.R.O. PART NO.	BEDFORD PART NO.	DESCRIPTION
18A	17-1708	Cage, Intake Ball
19A	23-1627	Spring, Intake Valve, 1-7/8"
27C-2	9-1728	Ball, PC Valve
114	13-932	50' x 1/4" Airless Hose Assembly
115	13-931	25' x 1/4" Airless Hose Assembly
117	13-453	50' x 3/8" Airless Hose Assembly
187A	14-2332	Inlet Strainer - 3/4" NPT Thread
187F	—	Order as: 187A (14-2332)
A7-120-2-007	20-2031	Kit - 007 Gun (Ball Holder & Seal)
A7-120-3-007	20-2032	Kit - 007 Gun (Complete)
A7-120-11	58-2001	Valve Spring Unit - 007 Gun
A7-120-21	19-2007	Lock nut
A7-120-33	2-2029	Seal, Teflon
A7-120-35	58-2022	Valve Seat - 007 Gun
A7-120-37	58-2024	Ball Holder

To order, contact your local
Paint Spray Equipment Dealer and ask for
Genuine Bedford Replacement Parts.

BEDFORD® Replacement Parts For . . . SHARPE Equipment

REPLACES SHARPE PART NO.	BEDFORD PART NO.	DESCRIPTION
10326	8-1807	Head Attach Gasket (1-20-28)
10332	44-1800	Trigger Shaft (1-20-34)
10333	19-1801	Trigger Screw (1-20-35)
16000	20-1794	Kit - 71 & 75PI Guns (1-70RK)
16100	8-1802	Tip Gasket (1-71-01)
16137	55-1803	Packings, 2-Pack (1-71-11A)
16139	8-1804	Packing (1-71-13)
16147	12-1805	Packing Nut (1-71-21)
16150	23-1806	Needle Spring (1-71-24)
16162	8-1808	Air Valve Packing (1-71-37)
16163	8-1809	Gasket (1-71-38)
16166	47-1810	Air Valve Assembly (1-71-41X)
16167	23-1811	Air Valve Spring (1-71-42)
16175	19-1812	"E" Clip (1-71-50)
25032	23-1813	Needle Spring (1-775-24)
25066	47-1814	Air Valve Assembly (1-775-41X)
25196	20-1795	Kit - 775PI Gun (1-775RK)

BEDFORD® Replacement Parts For . . . KREMLIN Equipment

To order, contact your local
Paint Spray Equipment Dealer and ask for
Genuine Bedford Replacement Parts.

REPLACES KREMLIN PART NO.	BEDFORD PART NO.	DESCRIPTION
102-201-914	55-2505	Retaining Rings (10-pack)
102-202-101	55-2506	Retaining Rings (10-pack)
109-130-311	55-2933	O-Rings (10-Pack)
129-029-903	55-2507	Seals, Sleeve (10-Pack)
129-529-903	55-2518	Teflon O-Rings (10-pack)
129-529-918	55-2509	Teflon O-Rings (10-pack)
129-609-902	55-2510	Seals (10-pack)
129-629-914	55-2512	Teflon O-Rings (10-pack)
129-659-901	20-2504	Gun Repair Kit - MX & MRX Spray Guns
129-739-910	55-2514	Valve Heads (10-pack)
129-971-002	55-2515	O-Rings (10-pack)
144-579-923	55-2516	O-Rings (10-pack)
144-850-150	20-2491	O-Ring Repair Kit - 350 Air Motor
150-040-309	55-2517	Teflon O-Rings (10-pack)
150-040-327	55-3212	Teflon O-Rings (5-pack)
668-300-035	55-2519	Teflon O-Rings (100-pack) Ref 129.529.903
668-300-043	55-2511	Teflon O-Rings (100-pack) Ref 129.629.914
668-300-044	55-2513	Valves Heads (5 x 10-pack) Ref 129.739.910
909-130-438	0-2489	O-Ring
909-420-108	0-2490	O-Ring
909-420-220	0-2486	O-Ring
909-420-259	0-2488	O-Ring

BEDFORD® Replacement Parts For . . . LARIUS Equipment

To order, contact your local
Paint Spray Equipment Dealer and ask for
Genuine Bedford Replacement Parts.

REPLACES LARIUS PART NO.	BEDFORD PART NO.	DESCRIPTION
11003	8-812	Tip Sealing Washer
11016	10-772	Washer
11017	23-771	Spring
11019	14-834	Gun Filter, 180 Mesh, Red
11020	8-808	Washer
11037	14-833	Gun Filter, 100 Mesh, Yellow
11038	14-832	Gun Filter, 50 Mesh, White
11202	58-1495	Diffuser
11203	—	Replaced by Wagner 149700 (58-2305)
11204	58-1493	Ball Holder
11205	—	Replaced by Wagner 149700 (58-2305)
11205A	2-594	Teflon Seal
11209	19-1598	Locknut



To order, contact your local
Paint Spray Equipment Dealer and ask for
Genuine Bedford Replacement Parts.

BEDFORD® Replacement Parts For . . . GLIDDEN Equipment

Quick Reference for . . . GLIDDEN Pumps Private Labeled by AMSPRAY

PUMP MODEL	COMPONENT DESCRIPTION	REPLACES AMSPRAY PART NO.	BEDFORD PART NO.
500 (Non-Sleeved Fluid Sections)	Repair Kit	04235	20-1783
	Rod	00191	57-1391
	Cylinder	00299	57-1431
	Piston Valve	00186	58-1737
	Intake Valve	00205	58-1709
500 (Sleeved Fluid Sections)	Repair Kit	04235	20-1783
	Rod	00191	57-1391
	Piston Valve	00186	58-1737
750 (Non-Sleeved Fluid Sections)	Repair Kit	04235	20-1783
	Rod	19206	57-1514
	Piston Valve	00186	58-1737
	Intake Valve	00205	58-1709
FORMULA I	Repair Kit	04239	20-1784
SPRINT (Non-Sleeved Fluid Sections)	Repair Kit	04235	20-1783
	Rod	00191	57-1391
	Cylinder	00299	57-1431
	Piston Valve	00186	58-1737
	Intake Valve	00205	58-1709
SPRINT (Sleeved Fluid Sections)	Repair Kit	04235	20-1783
	Rod	00191	57-1391
	Piston Valve	00186	58-1737

FOR OTHER AMSPRAY REPLACEMENT REPAIR PARTS,
REFER TO TITAN / WAGNER EQUIPMENT ON PAGES 45-47

Quick Reference for . . . GLIDDEN Pumps Private Labeled by WAGNER

PUMP MODEL	COMPONENT DESCRIPTION	REPLACES WAGNER PART NO.	BEDFORD PART NO.
400 SE	Repair Kit	294904	20-2065
500 SE	Repair Kit	294905	20-2066
750 SE	Repair Kit	279910	20-2263
1000 SE	Repair Kit	294920	20-2237

FOR OTHER WAGNER REPLACEMENT REPAIR PARTS,
REFER TO TITAN / WAGNER EQUIPMENT ON PAGES 45-59

Quick Reference for . . . GLIDDEN Pumps Private Labeled by AIRLESSCO

PUMP MODEL	COMPONENT DESCRIPTION	REPLACES AIRLESSCO PART NO.	BEDFORD PART NO.
ProSpray 402, 404, 505 & 606	Repair Kit	331-210	20-1999
ProSpray 808, 1000 & 1300	Repair Kit (Standard Kit)	187-040	20-1815
	Repair Kit (All Teflon Kit)	187-042	20-1947

FOR OTHER AIRLESSCO REPLACEMENT REPAIR PARTS,
REFER TO AIRLESSCO EQUIPMENT ON PAGES 3-4

BEDFORD® Replacement Parts

For . . . AMSPRAY Equipment

To order, contact your local
Paint Spray Equipment Dealer and ask for
Genuine Bedford Replacement Parts.

Quick Reference for . . . AMSPRAY Pumps

PUMP MODEL NAME	For the Bedford Replacement Part, refer to the following Amspray component P/N's				
	REPAIR KIT	ROD	CYLINDER / SLEEVE	PISTON VALVE	INTAKE VALVE
AMSPRAY					
AVENGER (396 FLUID SECT'S)	4235	191	299 (CYL)	186	205
AVENGER (EXCEL / 296 PUMPS)	4235	191	289 (SLV)	186	13363
AVENGER (PLANOTRONIC)	13292	—	—	—	310
BLACKBIRD	4239	—	—	—	—
BLUE MAX	4235	191	299(C) / 289(S)	186	205 or 13363
CORSAIR (396 FLUID SECT'S)	4235	191	299 (CYL)	186	205
CORSAIR (EXCEL / 296 PUMPS)	4235	191	289 (SLV)	186	13363
CORSAIR (PLANOTRONIC)	13292	—	—	—	310
FORMULA I S.E.	4239	—	—	—	—
MARAUDER	4239	—	—	—	—
MODEL 4	4235	191	299(C) / 289(S)	186	205 or 13363
MODEL 6	4235	191	299(C) / 289(S)	186	205 or 13363
MODEL 800	4239	—	—	—	—
PANTHER	4239	—	—	—	—
RC 125	13200	—	—	—	—
SPC 3000 G.E.	4235	191	299(C) / 289(S)	186	205 or 13363
TIGER	4239	—	—	—	—
FULLER O'BRIEN					
CHIEF	4235	191	299(C) / 289(S)	186	205 or 13363
MODEL 800	4239	—	—	—	—
SUPER CHIEF	4239	—	—	—	—
WARRIOR	4235	191	299(C) / 289(S)	186	205 or 13363
GLIDDEN					
500	4235	191	299(C) / 289(S)	186	205 or 13363
750	4235	19206	—	186	205 or 13363
FORMULA I	4239	—	—	—	—
SPRINT	4235	191	299(C) / 289(S)	186	205 or 13363
M.A.B.					
CHEETAH	4235	191	299(C) / 289(S)	186	205 or 13363
COUGAR	4235	191	299(C) / 289(S)	186	205 or 13363
PANTHER	4239	—	—	—	—
TIGER	4239	—	—	—	—

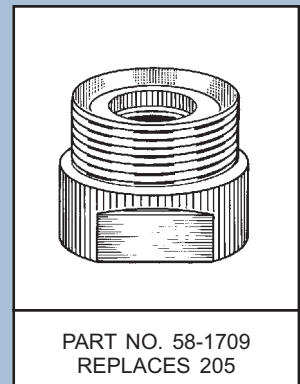
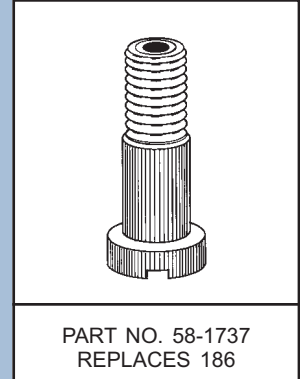

To order, contact your local
Paint Spray Equipment Dealer and ask for
Genuine Bedford Replacement Parts.

BEDFORD® Replacement Parts For . . . TITAN / WAGNER / SPEEFLO

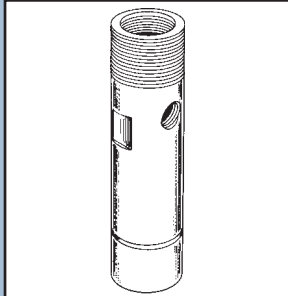

PART NO. 57-1431
REPLACES 299

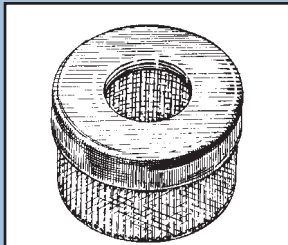

PART NO. 14-1325 8M
REPLACES 2975

PART NO. 14-1329 16M
REPLACES 2976

REPLACES TITAN PART NO.	BEDFORD PART NO.	DESCRIPTION
00043	18-1315	Female Adapter
00051	2-1357	Teflon V-Packing
00078	1-1633	Leather V-Packing
00086	18-1456	Male Adapter
00094	19-2655	Lower Packing Nut, Piston
00108	1-1634	Leather V-Packing
00116	—	Replaced by 08170 (49-1780)
00124	18-1538	Male Adapter
00132	18-1457	Female Gland
00159	—	Replaced by 00186 (58-1737)
00181	—	Replaced by 00191 (57-1391)
00186	58-1737	Piston Valve - 296 & 396 Fluid Sections
00191	57-1391	Rod - 396 Fluid Section
00203	15-1779	Teflon O-Ring
00205	58-1709	Foot Valve Assembly - 396 Fluid Section
00215	15-1532	Teflon O-Ring
00248	10-1671	Gasket
00264	19-1513	Ball Stop Pin
00299	57-1431	Cylinder - 396 Fluid Section
00310	58-2778	Intake Seat - EP2100/2300, EPX2305/2355
02975	14-1325	Inlet Strainer (Coarse), 3/4" NPT Thread
02976	14-1329	Inlet Strainer (Fine), 3/4" NPT Thread
04235	20-1783	Kit - 296, 396, 19308 Fluid Sections
04239	20-1784	Kit - 9000, 9024 Fluid Sections
04243	—	Replaced by 04235 (20-1783)
04245	—	Replaced by 04235 (20-1783)
04249	—	Replaced by 04239 (20-1784)
04339	14-1489	Strainer - 50 Mesh
04340	14-1490	Strainer - 100 Mesh
04341	15-1474	Teflon O-Ring
05568	20-1511	Kit - 296, 396, 19308 Fluid Sections (Teflon)
08070	49-1778	V-Packing
08080	49-1777	V-Packing
08170	49-1780	V-Packing
08180	49-1781	V-Packing
09075	18-1367	Female Adapter
09083	—	Replaced by 08070 (49-1778)
09091	1-1637	Leather V-Packing
09105	18-1368	Male Adapter
09120	—	Replaced by 04239 (20-1784)
09148	18-1369	Female Adapter
09156	—	Replaced by 08080 (49-1777)
09164	1-1639	Leather V-Packing
09172	18-1378	Male Adapter
09261	10-1379	Copper Gasket
09441	15-1536	Teflon O-Ring
09446	10-1882	Washer
10775	—	Replaced by 93638 (58-1700)
10778	8-807	Sealing Washer
10779	23-769	Outlet Valve Spring

BEDFORD® Replacement Parts

For . . . TITAN / WAGNER / SPEEFLO

To order, contact your local
Paint Spray Equipment Dealer and ask for
Genuine Bedford Replacement Parts.

REPLACES TITAN PART NO.	BEDFORD PART NO.	DESCRIPTION
10780	—	Replaced by 9970102 (10-768)
12386	9-1862	Ball
13055	19-1863	Retaining Ring
13057	49-1868	V-Packing
13090	1-1864	Leather V-Packing
13147	15-1850	Teflon O-Ring
13200	20-1861	Kit - RC125
13204	18-1865	Female Adapter
13206	18-1866	Male Adapter
13292	20-1886	Kit - "NEW" Avenger/Corsair, 91 Fluid Section
13359	58-2791	Outlet Seat - 945, 975, EP2105, EPX2155
13361	18-1883	Female Gland
13364	19-1884	Wave Spring
13367	0-1535	O-Ring
13381	15-1885	Teflon O-Ring
13402	15-1782	Teflon O-Ring
13481	12-2766	Piston Rod Retainer
13592	—	Replaced by 13292 (20-1886)
13597	—	Replaced by 00203 (15-1779)
13862	—	Replaced by 04239 (20-1784)
14068	14-2596	Filter Element, Outlet Manifold, 100 Mesh
14069	14-2595	Filter Element, Outlet Manifold, 50 Mesh
14072	15-2243	Teflon O-Ring
19206	57-1514	Rod - "750" Pump
25014	15-1844	Teflon O-Ring
25029	6-1843	Backup Ring
34377	14-832	Gun Filter, 50 Mesh, Medium (White)
34383	14-834	Gun Filter, 180 Mesh, Extra-Fine (Red)
34511	—	Replaced by 9941501 (9-809)
34512	23-767	Spring
36462	8-588	Support, Spring
43052	8-812	Tip Sealing Washer
43209	—	Replaced by 9922703 (19-1447)
43211	2-594	Teflon Seal - G10 Gun
43215	58-1493	Ball Holder Assembly
43225	58-1495	Diffuser Assembly, 11/16" - G10 Gun
43230	—	Replaced by 149700 (58-2305)
43232	—	Replaced by 149700 (58-2305)
43234	—	Replaced by 89324 (14-833)
43260	10-772	Washer
43269	—	Replaced by 347706 (47-2450)
43303	8-808	Washer
43553	—	Replaced by 9910201 (19-1598)
43590	23-771	Spring
47266	29-2600	Bypass Valve Assembly
47485	23-1389	Spring, Outlet
47486	—	Replaced by 93635 (9-1049)
50164	9-1640	Ball
50172	9-1641	Ball
50849	19-1867	Cotter Pin



PART NO. 14-1489 50M
REPLACES 4339

PART NO. 14-1490 100M
REPLACES 4340

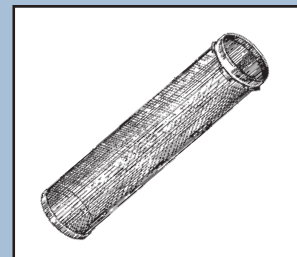

PART NO. 14-2595 50M
REPLACES 14069

PART NO. 14-2596 100M
REPLACES 14068

To order, contact your local
Paint Spray Equipment Dealer and ask for
Genuine Bedford Replacement Parts.

BEDFORD® Replacement Parts For . . . TITAN / WAGNER / SPEEFLO

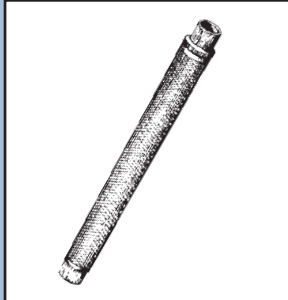

PART NO. 14-832
REPLACES 34377

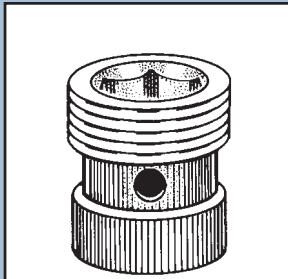

PART NO. 58-1700
REPLACES 93638

REPLACES TITAN PART NO.	BEDFORD PART NO.	DESCRIPTION
51055	12-1482	Plug, 1/4" NPT with Hex Socket End
51519	9-1642	Ball
51799	9-1643	Ball
51829	19-1644	Cotter Pin
51831	19-1316	Cotter Pin
51841	19-1377	Cotter Pin
55109	—	Replaced by 154014 (13-931)
55412	—	Replaced by 9970103 (10-770)
88005	12-403	Swivel Adapter 1/4" NPT(m) x 3/8" NPS(f)
88160	12-230	Nipple 3/8" NPT x 3/8" NPT
88161	12-404	Swivel Adapter 3/8" NPT(m) x 1/4" NPS(f)
88162	12-229	Nipple 1/4" NPT x 3/8" NPT
88241	14-856	Filter, Low Line
88537	20-1567	Kit - G10 Overhaul
88600	13-798	5' x 3/16" Airless Hose Assembly
89323	14-831	Gun Filter, 30 Mesh, Coarse (Green)
89324	14-833	Gun Filter, 100 Mesh, Fine (Yellow)
89494	8-2158	Seal, Outlet Seat
89957	55-891	Gun Filters, 2-pack, Green, 30 Mesh
89958	55-892	Gun Filters, 2-pack, White, 50 Mesh
89959	55-893	Gun Filters, 2-pack, Yellow, 100 Mesh
89960	55-894	Gun Filters, 2-pack, Red, 180 Mesh
93635	9-1049	Carbide Ball 6mm (was 47486)
93638	58-1700	Outlet Valve Seat (was 10775)
93654	0-1508	O-Ring
93896	12-228	Nipple 1/4" NPT x 1/4" NPT
0123423	49-2997	Polyethylene V-Packing
0123427	49-2991	Polyethylene V-Packing
0149700	58-2305	Needle Assembly - G10 Gun
0154014	13-931	25' x 1/4" Airless Hose Assembly (Blue)
0154015	13-932	50' x 1/4" Airless Hose Assembly (Blue)
0154675	55-893	Gun Filters, 2-pack, Yellow, 100 Mesh
0154842	55-892	Gun Filters, 2-pack, White, 50 Mesh
0154918	55-894	Gun Filters, 2-pack, Red, 180 Mesh
0154919	55-891	Gun Filters, 2-pack, Green, 30 Mesh
0270491	9-2309	Ball, 5/16" Carbide
0270954	20-1787	Kit - Outlet Valve
0270957	20-1751	Kit - G10 Spray Gun, 11/16" Diffuser Thread
0275520	54-84	Seal, White Plastic/Foam
0276258	—	Order as: (6) pcs 275520 (54-84)
0279625	20-2300	Kit - G-10 Spray Gun, 7/8" Diffuser Thread
0279910	20-2263	Kit - 975, EP2400, 750SE
0279919	20-2160	Kit - G10 Spray Gun, 7/8" Diffuser Thread
0290237	57-3038	Rod Assembly - 740 Impact, 840 Impact
0290251	57-3040	Rod - 740 Impact, 840 Impact
0290276	8-3186	Spacer
0290277	57-2700	Piston Rod
0291374	1-2993	Leather V-Packing
0291375	1-2994	Leather V-Packing
0291390	18-2995	Support Ring, Female Gland

BEDFORD® Replacement Parts

For . . . TITAN / WAGNER / SPEEFLO

To order, contact your local
Paint Spray Equipment Dealer and ask for
Genuine Bedford Replacement Parts.

REPLACES TITAN PART NO.	BEDFORD PART NO.	DESCRIPTION
0291407	18-2996	Pressure Ring, Male Gland
0291444	18-2998	Pressure Ring, Male Gland
0294301	23-2068	Retaining Ring
0294326	18-2067	Male Adapter
0294358	18-2169	Male Adapter
0294375	18-2069	Female Adapter, Lower
0294376	18-2070	Male Adapter, Upper
0294377	18-2071	Female Adapter, Upper
0294379	23-2072	Wave Spring, Upper
0294381	18-2073	Female Adapter, Lower
0294484	18-2074	Female Adapter, Lower
0294499	8-2592	Seal, Dump Valve
0294516	58-2593	Outlet Seat - EP 2510, EPX 2305/2405/2505
0294676	—	Replaced by 294905 (20-2066)
0294678	—	Replaced by 279910 (20-2263)
0294904	20-2065	Kit - 40 OSE, EP2100
0294905	20-2066	Kit - EP2300, SPC-3900, 500SE
0294914	—	Replaced by 294904 (20-2065)
0294920	20-2237	Kit - Glidden 1000SE
0294966	20-2590	Kit - Prime/Spray Valve
0295306A	57-2602	Rod - EP2005, EP2105, 935, 945
0295307	46-2622	Outlet Ball Guide
0295308	18-2627	Upper Spacer
0295309	18-2623	Lower Spacer
0295310	49-2624	Upper Packing
0295311	49-2625	Lower Packing
0295362	18-2754	Lower Spacer
0295363	18-2753	Upper Spacer
0295366	15-2749	Teflon O-Ring
0295378	49-2751	T-Lip Packing, Upper
0295379	49-2752	T-Lip Packing, Lower
0295404	58-2735	Diffuser - G10XL, G12XL, AG-08
0295516A	57-2604	Rod - EP2205, DSP2500, 965
0295565	14-2870	Inlet Strainer, 3/4" UNF Thread, 16 Mesh
0295900	20-2603	Kit - EP2105
0295904	20-2750	Repair Kit - EP2205
0295915	20-2652	Kit - 935, 945
0295989	20-2653	Kit - EP2005
0296261	58-2735	Diffuser - G10XL, G12XL, AG-08
0296270	47-2736	Needle Assembly - G10XL, G12XL
0296288	14-832	Outlet/Gun Filter, 50 Mesh, Medium (White)
0296289	8-2929	Seal, Handle
0296294	20-2737	Kit - G-10XL, G-12XL, AG-08
0347706A	47-2450	Gun Swivel - G-10
0349009	20-571	Packing Set - Lower (L/PE)
0349238	20-1673	Packing Set (L/PE)
0349383	0-2444	O-Ring
0349408	15-1473	Teflon O-Ring
0349411	57-2594	Rod
0349416	57-2587	Cylinder - PT 8900GH, 10000, 12000GH

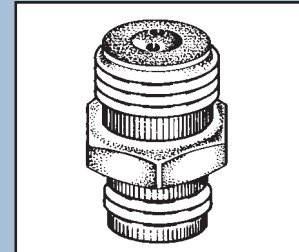

PART NO. 58-1495 "F"
REPLACES 43225 Thd

PART NO. 58-2735 "G"
REPLACES 0296261 Thd



PART NO. 20-1751 "F"
REPLACES 270957 Thd

PART NO. 20-2160 "G"
REPLACES 279919 Thd

To order, contact your local
Paint Spray Equipment Dealer and ask for
Genuine Bedford Replacement Parts.

BEDFORD® Replacement Parts For . . . TITAN / WAGNER / SPEEFLO

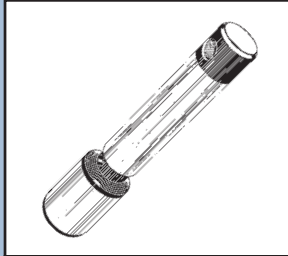

PART NO. 57-2602
REPLACES 295306

PART NO. 57-2604
REPLACES 295516

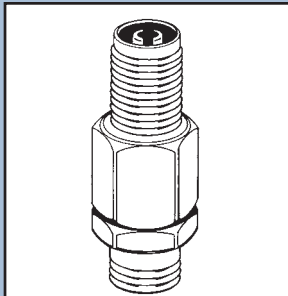

PART NO. 47-2450
REPLACES 347706

REPLACES TITAN PART NO.	BEDFORD PART NO.	DESCRIPTION
0349507	57-2270	Piston Rod
0349704	14-2346	Outlet Filter Element with Ball - 50 Mesh
0502022	8-2156	Tip Gasket, 1/8"
0507211	57-2836	Rod Assembly - EPX2305
0507229	57-2828	Rod Assy - EPX2405/2455, EPX2505/2555
0507272	—	Replaced by 700-601A (49-2187)
0507273A	49-2970	Upper Packing Assembly
0507274A	49-2971	Lower Packing Assembly
0507452	44-2824	Outlet Ball Cage
0507454	8-2819	Washer
0507690	29-2600	Bypass Valve Assembly
0507730	0-2978	O-Ring
0507731	6-2979	Teflon Backup Ring
0507732	57-2822	Rod - EPX2405/2455, EPX2505/2555
0507733	44-2825	Retainer, Outlet Valve
0507734	8-2821	Seal, Outlet Seat
0507736	19-2611	Dowel Pin, 1/8" x 3/8", Cam Base
0507741	0-2105	O-Ring
0507742	12-2617	Retainer, Drain Valve
0507743	58-2608	Stem Assembly, Drain Valve
0507745	10-2109	Bypass Gasket
0507789	23-2992	Wave Spring
0507923	20-3000	Kit - EPX2405, EPX2505
0507928	57-2742	Rod - EPX2305
0507931	47-2610	Cam Base & Pin Assembly, Drain Valve
0507945	44-2827	Outlet Ball Cage
0508221	20-3187	Kit - ProSpray 27 / 30 / 31 / 3.29 / 3.31 / 3.34
0508315	15-2626	Teflon O-Ring
0508449	14-3108	Outlet Filter, 30 Mesh
0508450	14-3109	Outlet Filter, 100 Mesh
0508451	14-2866	Outlet Filter, 30 Mesh
0508452	14-2868	Outlet Filter, 100 Mesh
0508593	44-2974	Piston Guide
0508597	57-2800	Rod - PS25
0508598	44-2975	Piston Bushing
0508599	15-2976	Teflon O-Ring
0508604	15-2860	Teflon O-Ring
0508606	0-2887	O-Ring, Solvent Resistant
0508665	8-2767	Piston Guide
0508672	9-2129	Outlet Ball
0508676	44-2738	Bushing, Piston Guide
0508708	8-2980	Packing Support Ring
0508712	8-2845	Wear Ring
0508718	21-2840	Packing Installation Tool
0508738	14-2081	Inlet Screen, 3/4" UNF
0508739	8-2769	Nylon Washer
0508743	15-2137	Teflon O-Ring
0508744	46-2619	Handle, Prime Valve
0508748	14-2747	Outlet Filter, 60 Mesh
0508749	23-3129	Support Spring, Outlet Filter

BEDFORD® Replacement Parts

For . . . TITAN / WAGNER / SPEEFLO

To order, contact your local
Paint Spray Equipment Dealer and ask for
Genuine Bedford Replacement Parts.

REPLACES TITAN PART NO.	BEDFORD PART NO.	DESCRIPTION
0508967	20-2833	Kit - G-15XL Spray Gun
0508997	8-2136	Gasket
0508999	15-2112	Teflon O-Ring
0509581	8-2792	Seal, Foot Valve
0509582	15-2764	Teflon O-Ring
0509583	9-2763	Ball
0509584	8-2793	Upper Guide
0509585	8-2110	Gasket, Outlet
0509586	8-2144	Upper Seal
0509587	15-2122	Teflon O-Ring
509590	—	Replaced by 704-289 (44-2738)
0509591	44-3006	Ball Cage
0509707	9-477	Ball
0509708	15-2699	Teflon O-Ring
0509710	9-1183	Ball, SS
0509762A	14-2748	Inlet Strainer, for 1-1/4" Suction Tube
0509856	19-2089	Locknut
0509873	12-219	Nipple 1/4" NPT x 1/4" NPS
0515220A	14-833	Gun Filter, 100 Mesh, Fine (Yellow)
0515252A	14-832	Gun Filter, 50 Mesh, Medium (White)
0515253B	14-834	Gun Filter, 180 Mesh, Extra-Fine (Red)
0516303	9-2129	Outlet Ball
0516731	55-894	Gun Filters, 2-pack, Red, 180 Mesh
0516732	55-893	Gun Filters, 2-pack, Yellow, 100 Mesh
0516733	55-892	Gun Filters, 2-pack, White, 50 Mesh
0516734	55-891	Gun Filters, 2-pack, Green, 30 Mesh
0516746	20-2773	Kit - XT440
0523928	20-3183	Kit - XI345, XI445
0551511	21-2973	Packing Insertion Tool
0551533	20-2798	Kit - EPX 2155/2255, SW419, RentSpray 400
0551534	58-2437	Intake Valve Seat
0551535	10-2768	Spacer
0551536	57-2770	Piston Rod Assy - EPX2155/2255, SW419
0551537	57-2790	Piston Rod - EPX2155/2255, SW419
0551538	49-2782	Upper Packing Assembly with Tool
0551539	49-2789	Lower Packing Assembly
0551620	58-2691	Outlet Valve Seat
0551669	57-2830	Rod - EPX2355
0551677	20-2977	Kit - EPX2355
0551678	57-2832	Rod Assembly - EPX2355
0551687	20-2987	Kit - EPX 2455/2555, Advantage 700/1100
0551951	15-2744	Teflon O-Ring
0552150	21-2986	Packing Pre-Form Tool
0552177	49-2981	Upper Packing Assembly
0552178	49-2984	Lower Packing Assembly
0552951	20-3175	Kit - Advantage 400, Advantage 500
0555002	—	Replaced by 705-103 (44-2809)
0555348	20-1857	Kit - LineCoat 820
0555371	20-2152	Kit - LineCoat 840 / 860
0555479	9-654	Ball

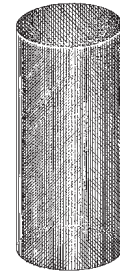

PART NO. 14-905
REPLACES 103-624



PART NO. 14-2297
REPLACES 103-625

PART NO. 14-2299
REPLACES 103-627

To order, contact your local
Paint Spray Equipment Dealer and ask for
Genuine Bedford Replacement Parts.

BEDFORD® Replacement Parts

For . . . TITAN / WAGNER / SPEEFLO

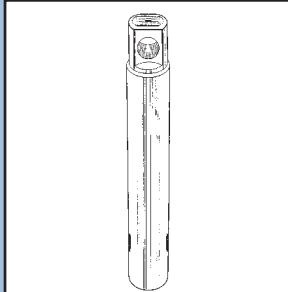

PART NO. 57-2274
REPLACES 143-117

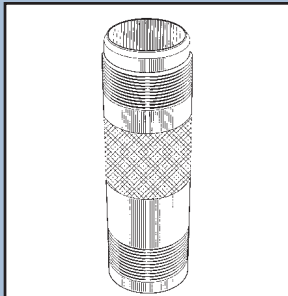

PART NO. 57-2329
REPLACES 143-822

REPLACES TITAN PART NO.	BEDFORD PART NO.	DESCRIPTION
0555602	29-2835	Bypass Valve Assy, Solvent Resistant O-Ring
0555652	8-2745	Gasket
0555669	8-2772	Seal, Outlet Valve
0555960	20-3035	Kit - Advantage GPX 85, PowrLiner 2850
0556038	20-2737	Kit - G-10XL, G-12XL, AG-08
0558740	20-3192	Kit - Impact 1040, Impact 1140
5000172	9-479	Ball
5000529	6-2106	Teflon Backup Ring
5005037	9-876	Ball
5005170	9-652	Ball
5006536	14-2682	Inlet Strainer, 1-5/16" Thread
5006543	19-2618	Grooved Pin, Drain Valve
5006547	0-2111	O-Ring
5152523	55-892	Gun Filters, 2-pack, White, 50 Mesh
9841502	9-2591	Ball, 10mm, Carbide
9871045	0-2565	O-Ring
9871046	0-2577	O-Ring
9871056	0-3102	O-Ring
9871105	0-2765	O-Ring
9871145	0-2186	O-Ring
9871160	0-2838	O-Ring
9894225	23-2999	Wave Spring
9894231	23-2236	Wave Spring
9910201	19-1598	Nut
9922703	19-1447	Retaining Ring (was 43209)
9941501	9-809	Carbide Ball 11mm (was 34511)
9941504	—	Replaced by 93635 (9-1049)
9941518	9-2651	Ball, 11mm Stainless Steel
9970102	10-768	Sealing Washer (was 10780)
9970103	10-770	Washer (was 55412)
103-624	14-905	Screen, Inlet Sump - 50 Mesh
103-625	14-2297	Rock Catcher Assembly - 1" OD Tube
103-627	14-2299	Rock Catcher Assembly - 1-1/4" OD Tube
106-002A	20-1673	Packing Set (L/PE)
106-011A	58-2405	Piston Valve - PowrTwin 3500 & 4500, Scout
106-014	0-1679	O-Ring
106-015	15-1681	Teflon O-Ring
106-050	20-1685	Kit - PowrTwin JR, Scout, Super Scout (L/PE)
106-051	—	Replaced by 106-050 (20-1685)
106-116	44-1683	Sleeve, Spring
107-029	57-2270	Rod - PowrTwin 3500/4500
107-051	20-1857	Kit - PowrTwin 3500/4500 (L/PE)
107-060	8-2745	Gasket, Seat
107-501	—	Order (1) each: 107-029, 107-936, 107-051
107-936	—	Replaced by 107-946 (57-3219)
107-946	57-3219	Cylinder - PowrTwin 3500 / 4500
108-021	—	Order as: 107-029 (57-2270)
108-940	—	Order as: 107-936 (57-2343)
138-019	8-1210	Gasket
138-025	—	Replaced by 138-225 (9-1183)

BEDFORD® Replacement Parts

For . . . TITAN / WAGNER / SPEEFLO

To order, contact your local
Paint Spray Equipment Dealer and ask for
Genuine Bedford Replacement Parts.

REPLACES TITAN PART NO.	BEDFORD PART NO.	DESCRIPTION
138-031	8-567	Nylon Gasket
138-052A	20-570	Packing Set - Upper (L/PE)
138-053A	20-1213	Packing Set - Upper (L/T)
138-054	20-1858	Packing Set - Upper (T/PE)
138-153A	20-571	Packing Set - Lower (L/PE)
138-154A	20-1214	Packing Set - Lower (L/T)
138-225	9-1183	Ball, SS
138-252A	20-1851	Packing Set - Upper (L/T)
138-253A	20-1852	Packing Set - Lower (L/T)
138-256	—	Replaced by 138-053 (20-1213)
138-257	—	Replaced by 138-154 (20-1214)
138-258	—	Replaced by 138-052 (20-570)
138-259	—	Replaced by 138-153 (20-571)
138-340	9-534	Ball
138-520A	20-1869	Packing Set - Upper (T)
138-521	—	Replaced by 138-520 (20-1869)
138-522A	20-1870	Packing Set - Lower (T)
138-523A	20-1859	Packing Set - Lower (T/PE)
138-917	57-2180	Rod - PowrTwin Classic, Atlas 30, Cmdr 60
138-941	—	Replaced by 143-945 (58-2327)
140-009	0-565	Foot Valve O-Ring
140-051	20-572	Kit - PowrTwin, Commander 60 (L/PE)
140-052	20-1215	Kit - PowrTwin, Commander 60 (L/T)
140-053	20-1871	Kit - PowrTwin, Commander 60 (T)
141-007	0-2441	O-Ring
143-019	10-1849	Retaining Ring
143-025	15-2699	Intake Seat O-Ring (XLT)
143-050	20-1853	Kit - PowrTwin 5500 (L/PE)
143-051	—	Replaced by 143-050 (20-1853)
143-117	57-2274	Rod - PowrTwin 5500, PowrTwin 6900
143-127	57-2274	Rod - PowrTwin 5500, PowrTwin 6900
143-500	—	Order (1) ea: 143-050, 143-117, 143-822
143-822	57-2329	Cylinder - PowrTwin 5500
143-945A	58-2327	Piston Valve - PowrTwin, PT5500, Cmdr 60
144-050	20-2152	Kit - PowrTwin 8900GH, 10000, 12000GH
144-051	20-2967	Kit - 6900XLT/Di, 8900XLT/Di, 12000XLT/Di
144-117	57-2594	Rod - PowrTwin 8900GH / 10000 / 12000GH
144-500	—	Order (1) ea: 144-050, 144-117, 144-822
144-822	57-2587	Cylinder - PT 8900GH / 10000 / 12000GH
144-832	—	Order as: 144-822 (57-2587)
145-031	15-1473	Teflon O-Ring
145-051	20-1471	Kit - PowrTwin Classic, Atlas, Ensign (L/PE)
145-052	20-1472	Kit - PowrTwin Classic, Atlas, Ensign (L/T)
145-054	—	Replaced by 145-052 (20-1472)
145-055	—	Replaced by 145-051 (20-1471)
145-060	—	Replaced by 145-051 (20-1471)
145-061	—	Replaced by 145-052 (20-1472)
145-500	—	Order (1) ea: 145-051, 145-922, 138-917
145-501	—	Order (1) ea: 145-052, 145-922, 138-917
145-502	—	Order (1) ea: 148-050, 145-922, 138-917

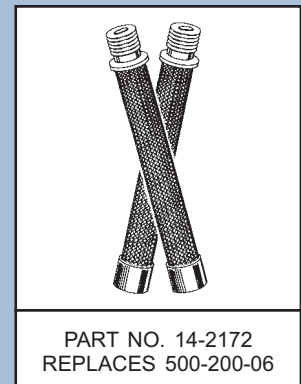
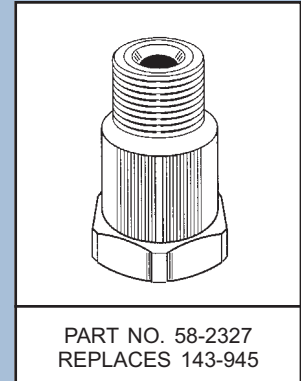

To order, contact your local
Paint Spray Equipment Dealer and ask for
Genuine Bedford Replacement Parts.

BEDFORD® Replacement Parts For . . . TITAN / WAGNER / SPEEFLO

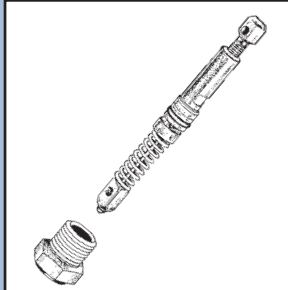

PART NO. 20-2088
REPLACES 520-025

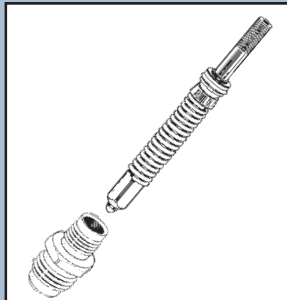

PART NO. 20-2095
REPLACES 580-034

REPLACES TITAN PART NO.	BEDFORD PART NO.	DESCRIPTION
145-922	57-2345	Cylinder - PT Classic, Atlas 30, Ensign 12
148-050	20-1854	Kit - 148 Series Pumps (L/T)
148-051	20-1860	Kit - 148 Series Pumps (T/PE)
160-124	—	Order as: (24) pcs 160-100 (14-516)
160-524	—	Order as: (24) pcs 160-500 (14-517)
173-133	15-1187	Teflon O-Ring
174-001	15-562	Teflon O-Ring
174-025A	20-1698	Packing Set - Lower (L/T)
174-050	20-573	Kit - Ranger 3:1 (L/T)
174-051	20-865	Kit - Ranger 3:1 (L/T)
174-052	20-1692	Kit - Ranger 3:1, Trident 3:1, 174-554 Pump (T)
174-055	20-1699	Kit - Ranger 3:1 (L/T/SS)
174-056	20-1701	Kit - Trident 3:1, 174-554 Pump (L/T)
174-058	20-1206	Kit - Ranger 3:1, Trident 3:1, 174-554 Pump (T)
174-059	—	Replaced by 174-058 (20-1206)
175-001A	20-574	V-Packing Set - Upper (L/T)
175-002	20-589	Cup Packing Set - Lower (L/T)
175-121	—	Replaced by 178-320 (20-1203)
175-220	—	Replaced by 178-320 (20-1203)
175-222	20-1204	Cup Packing Set - Lower (T)
178-001A	20-1270	Packing Set - Upper (L/PE)
178-007	—	Replaced by 178-700 (9-477)
178-320A	20-1203	Packing Set - Upper (T/SS)
178-420A	20-1702	Packing Set - Upper (L/T)
178-700	9-477	Ball
180-002A	20-576	Packing Set - Lower (L/T)
180-122	—	Replaced by 180-322 (20-1690)
180-124	—	Replaced by 180-322 (20-1690)
180-322A	20-1690	Packing Set - Lower (T)
182-007	15-561	Teflon O-Ring
182-050	20-579	Pump Service Kit Minor (L/T)
182-921A	58-2605	Piston Valve - HydraPro III/IV, Cmdr, Admrl
183-001A	20-1279	Packing Set - Lower (L/PE)
183-050	—	Replaced by 185-051 (20-1319)
183-051	—	Replaced by 185-050 (20-1318)
183-052	—	Replaced by 185-052 (20-1691)
183-053	—	Replaced by 185-050 (20-1318)
183-230	0-880	O-Ring
183-930	57-2341	Cylinder - HydraPro IV/Super, Cmdr 30, Boss
185-050	20-1318	Kit - HydraPro III/IV/Super, Admrl, Boss (L/PE)
185-051	20-1319	Kit - HydraPro III/IV/Super, Admrl, Boss (L/T)
185-052	20-1691	Kit - HydraPro III/IV/Super, Admrl, Boss (T)
185-984A	57-2272	Rod - HydraPro IV/Super, Admrl, Boss, Cmdr
200-551	12-403	Swivel Adapter 1/4" NPT(m) x 3/8" NPS(f)
200-555	12-465	Swivel Adapter 1/2" NPT(m) x 1/2" NPS(f)
201-520	20-2681	Kit - XLT Intake O-Ring & Outlet Washer
201-525	20-2746	O-Ring & Gasket, Seats
203-316	13-792	3' x 3/16" Airless Hose Assembly
211-029	—	Replaced by 211-129 (9-1697)
211-129	9-1697	Ball

BEDFORD® Replacement Parts

For . . . TITAN / WAGNER / SPEEFLO

To order, contact your local
Paint Spray Equipment Dealer and ask for
Genuine Bedford Replacement Parts.

REPLACES TITAN PART NO.	BEDFORD PART NO.	DESCRIPTION
221-008	0-2103	O-Ring
221-011	0-2104	O-Ring
221-012	0-2105	O-Ring
222-012	6-2106	Backup Ring
226-001	19-2089	Locknut, LX-80
227-006	12-219	Nipple 1/4" NPT x 1/4" NPS
227-027	12-2138	Plug, Manifold
227-100	28-759	Gauge, 1/4" NPT Btm Mnt, 0-100 PSI, 2"
234-702	0-1193	O-Ring
235-026	0-2442	O-Ring
235-027	16-2436	Piston Seal
235-028	16-2438	Rod Seal
235-050	20-2439	Hydraulic Motor Kit - PTwin 3500/4500/5500
236-011	8-2698	Piston Seat Washer (XLT)
236-032	8-2772	Seal, Outlet Seat - XLT
240-001A	20-2390	Packing Set - Hydra M 4000 (Ctr)
245-050	20-2396	Kit - Hydra M 4000 (Ctr)
314-180	9-876	Ball
316-505	—	Order: Bedford 13-932 Hose Assy
325-005	23-2446	Trip Spring
420-065	—	Order as: 4-1/2' of Cut-Length 3/4" Hose
420-070	13-2558	1" x 5' Fluid Hose, Cut Length, No Fittings
425-029	—	Replaced by 858-812 (19-1217)
426-016	0-1196	O-Ring
426-051	22-864	Sealant
431-019A	20-2872	O-Ring / Backup Ring Set
431-032	0-2443	O-Ring
432-628	—	Replaced by 872-005 (8-1657)
441-152	0-2444	O-Ring
441-217	0-2445	O-Ring
500-200-03	14-2171	Gun Filter (2 pcs), 30 Mesh, Coarse, Green
500-200-06	14-2172	Gun Filter (2 pcs), 60 Mesh, Medium, White
500-200-10	14-2173	Gun Filter (2 pcs), 100 Mesh, Fine, Yellow
500-200-15	14-2174	Gun Filter (2 pcs), 150 Mesh, Extra-Fine, Red
520-018	—	Replaced by 520-093 (58-2620)
520-020	10-2083	Washer
520-023A	58-2087	Seal Assembly
520-025	20-2088	Kit - SGX-20 Gun
520-048	58-2086	Diffuser - SGX-20 Gun
520-093	—	Replaced by 520-099 (58-2620)
520-099	58-2620	Diffuser - LX-80
540-030	14-2161	Gun Filter, 30 Mesh, Green
540-060	14-2162	Gun Filter, 60 Mesh, White
540-100	14-2163	Gun Filter, 100 Mesh, Yellow
540-150	14-2164	Gun Filter, 150 Mesh, Red
541-025	3-559	Leather Cup Packing
541-026	17-618	Washer
541-125	4-560	Teflon Cup Packing
541-126	8-1198	Washer
550-271	—	Order as: Wagner 89958 (55-892)
550-272	—	Order as: Wagner 89957 (55-891)
550-273	—	Order as: Wagner 89959 (55-893)
550-274	—	Order as: Wagner 89960 (55-894)
550-483	—	Order as: Wagner 89958 (55-892)
550-484	—	Order as: Wagner 89957 (55-891)

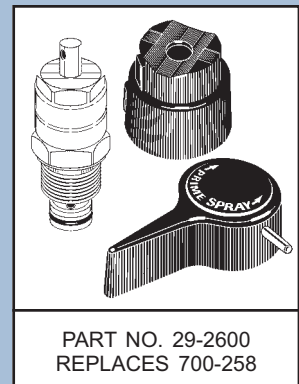
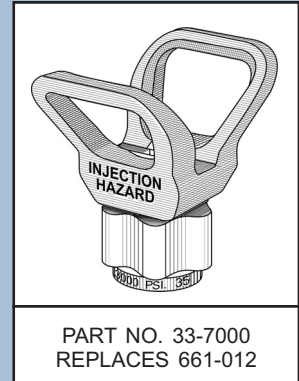

To order, contact your local
Paint Spray Equipment Dealer and ask for
Genuine Bedford Replacement Parts.

BEDFORD® Replacement Parts For . . . TITAN / WAGNER / SPEEFLO

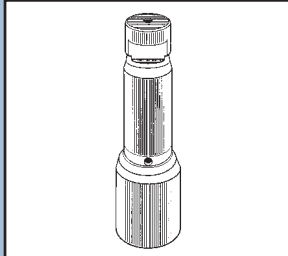

PART NO. 57-2264
REPLACES 700-580

PART NO. 57-2720
REPLACES 704-560

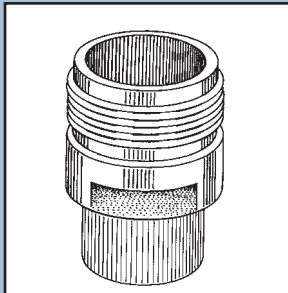

PART NO. 58-2134
REPLACES 700-608

REPLACES TITAN PART NO.	BEDFORD PART NO.	DESCRIPTION
550-485	—	Order as: Wagner 89959 (55-893)
550-486	—	Order as: Wagner 89960 (55-894)
558-015	—	Replaced by 872-005 (8-1657)
560-038	8-2834	Seal - Outlet Filter / Gun Handle
568-051A	20-852	Packing Set - Upper (L/T)
568-052A	20-585	Packing Set - Lower (L/T)
568-521A	20-586	Packing Set - Upper (T)
568-522A	20-587	Packing Set - Lower (T)
569-016	9-652	Ball
569-017	9-653	Ball
569-021	9-654	Ball
569-023	10-851	Gasket
569-120	8-598	Gasket
580-017	—	Replaced by 580-510 (58-2094)
580-034A	20-2095	Kit - LX-80 & LX-80II Guns
580-510A	58-2094	Needle Seal Assembly - LX-80 Gun
580-530	47-2450	Gun Swivel - G-10
581-059	14-831	Outlet/Gun Filter, 30 Mesh, Coarse (Green)
581-060	14-832	Outlet/Gun Filter, 50 Mesh, Medium (White)
581-061	14-834	Gun Filter, 180 Mesh, Extra-Fine (Red)
581-062	14-833	Gun Filter, 100 Mesh, Fine (Yellow)
661-012	33-7000	Hand-Tight Reversible Tip Guard, 7/8" (G)
661-015	33-7002	Hand-Tight Reversible Tip Guard, 11/16" (F)
662-207	33-7207	Reversible Tip - .007" Orifice, 4"-6" Fan
662-209	33-7209	Reversible Tip - .009" Orifice, 4"-6" Fan
662-211	33-7211	Reversible Tip - .011" Orifice, 4"-6" Fan
662-213	33-7213	Reversible Tip - .013" Orifice, 4"-6" Fan
662-215	33-7215	Reversible Tip - .015" Orifice, 4"-6" Fan
662-217	33-7217	Reversible Tip - .017" Orifice, 4"-6" Fan
662-219	33-7219	Reversible Tip - .019" Orifice, 4"-6" Fan
662-309	33-7309	Reversible Tip - .009" Orifice, 6"-8" Fan
662-311	33-7311	Reversible Tip - .011" Orifice, 6"-8" Fan
662-313	33-7313	Reversible Tip - .013" Orifice, 6"-8" Fan
662-315	33-7315	Reversible Tip - .015" Orifice, 6"-8" Fan
662-317	33-7317	Reversible Tip - .017" Orifice, 6"-8" Fan
662-319	33-7319	Reversible Tip - .019" Orifice, 6"-8" Fan
662-321	33-7321	Reversible Tip - .021" Orifice, 6"-8" Fan
662-323	33-7323	Reversible Tip - .023" Orifice, 6"-8" Fan
662-325	33-7325	Reversible Tip - .025" Orifice, 6"-8" Fan
662-327	33-7327	Reversible Tip - .027" Orifice, 6"-8" Fan
662-411	33-7411	Reversible Tip - .011" Orifice, 8"-10" Fan
662-413	33-7413	Reversible Tip - .013" Orifice, 8"-10" Fan
662-415	33-7415	Reversible Tip - .015" Orifice, 8"-10" Fan
662-417	33-7417	Reversible Tip - .017" Orifice, 8"-10" Fan
662-419	33-7419	Reversible Tip - .019" Orifice, 8"-10" Fan
662-421	33-7421	Reversible Tip - .021" Orifice, 8"-10" Fan
662-423	33-7423	Reversible Tip - .023" Orifice, 8"-10" Fan
662-425	33-7425	Reversible Tip - .025" Orifice, 8"-10" Fan
662-427	33-7427	Reversible Tip - .027" Orifice, 8"-10" Fan
662-429	33-7429	Reversible Tip - .031" Orifice, 8"-10" Fan
662-431	33-7431	Reversible Tip - .031" Orifice, 8"-10" Fan
662-511	33-7511	Reversible Tip - .011" Orifice, 10"-12" Fan
662-513	33-7513	Reversible Tip - .013" Orifice, 10"-12" Fan
662-515	33-7515	Reversible Tip - .015" Orifice, 10"-12" Fan
662-517	33-7517	Reversible Tip - .017" Orifice, 10"-12" Fan

BEDFORD® Replacement Parts

For . . . TITAN / WAGNER / SPEEFLO

To order, contact your local
Paint Spray Equipment Dealer and ask for
Genuine Bedford Replacement Parts.

REPLACES TITAN PART NO.	BEDFORD PART NO.	DESCRIPTION
662-519	33-7519	Reversible Tip - .019" Orifice, 10"-12" Fan
662-521	33-7521	Reversible Tip - .021" Orifice, 10"-12" Fan
662-523	33-7523	Reversible Tip - .023" Orifice, 10"-12" Fan
662-525	33-7525	Reversible Tip - .025" Orifice, 10"-12" Fan
662-527	33-7527	Reversible Tip - .027" Orifice, 10"-12" Fan
662-529	33-7529	Reversible Tip - .029" Orifice, 10"-12" Fan
662-531	33-7531	Reversible Tip - .031" Orifice, 10"-12" Fan
662-535	33-7535	Reversible Tip - .035" Orifice, 10"-12" Fan
662-615	33-7615	Reversible Tip - .015" Orifice, 12"-14" Fan
662-617	33-7617	Reversible Tip - .017" Orifice, 12"-14" Fan
662-619	33-7619	Reversible Tip - .019" Orifice, 12"-14" Fan
662-621	33-7621	Reversible Tip - .021" Orifice, 12"-14" Fan
662-623	33-7623	Reversible Tip - .023" Orifice, 12"-14" Fan
662-625	33-7625	Reversible Tip - .025" Orifice, 12"-14" Fan
662-627	33-7627	Reversible Tip - .027" Orifice, 12"-14" Fan
662-629	33-7629	Reversible Tip - .029" Orifice, 12"-14" Fan
662-631	33-7631	Reversible Tip - .031" Orifice, 12"-14" Fan
662-633	33-7633	Reversible Tip - .033" Orifice, 12"-14" Fan
662-635	33-7635	Reversible Tip - .035" Orifice, 12"-14" Fan
662-717	33-7717	Reversible Tip - .017" Orifice, 14"-16" Fan
662-721	33-7721	Reversible Tip - .021" Orifice, 14"-16" Fan
662-723	33-7723	Reversible Tip - .023" Orifice, 14"-16" Fan
662-725	33-7725	Reversible Tip - .025" Orifice, 14"-16" Fan
662-819	33-7819	Reversible Tip - .019" Orifice, 16"-18" Fan
694-003	0-564	O-Ring
694-051	20-853	Kit - Ensign 35:1 (L/T)
700-024	0-2275	O-Ring
700-072A	49-2190	Upper Seal - 440e, 447ex, 660ex, 690gx
700-201	0-2107	O-Ring
700-203	22-2206	Grease
700-240	—	Replaced by 700-258 (29-2600)
700-244	23-2616	Spring
700-248	12-2617	Retainer, Drain Valve
700-250	58-2608	Stem Assembly, Drain Valve
700-252A	47-2610	Cam Base & Pin Assembly, Drain Valve
700-258	29-2600	Bypass Valve Assembly
700-499	0-2108	O-Ring
700-537	10-2109	Bypass Gasket
700-580A	57-2264	Rod - Epic 440e, 447ex, 660ex, 690gx
700-583	58-2100	Inlet Valve - 440e, 447ex, 660ex, 690gx
700-585	58-2102	Outlet Valve - 440e, 447ex, 660ex, 690gx
700-587	8-2207	Upper Guide
700-601A	49-2187	Seal - 440e, 447ex, 660ex, 690gx, 440HP
700-603	—	Replaced by 700-072 (49-2190)
700-697	46-2619	Valve Handle, Drain Valve
700-721	0-2111	O-Ring
700-759	19-2618	Grooved Pin, Drain Valve
700-790	—	Replaced by 702-130 (20-2208)
700-793	21-2203	Piston Guide Tool
700-804	8-2110	Gasket, Outlet
700-805	14-2081	Inlet Screen - 440e, 447ex, 660ex, 690gx
700-815	—	Replaced by 702-140 (20-2209)
700-821	8-2135	Foot Valve Seal
700-823	19-2611	Dowel Pin, 1/8" x 3/8", Cam Base
700-881	8-2136	Gasket

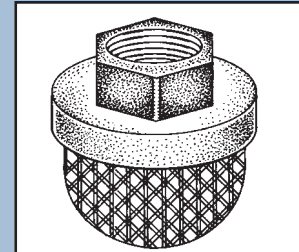

PART NO. 14-2081 3/4"
REPLACES 700-805

PART NO. 14-2082 1-5/16"
REPLACES 710-046A



PART NO. 20-2209
REPLACES 702-140

To order, contact your local
Paint Spray Equipment Dealer and ask for
Genuine Bedford Replacement Parts.

BEDFORD® Replacement Parts For . . . TITAN / WAGNER / SPEEFLO

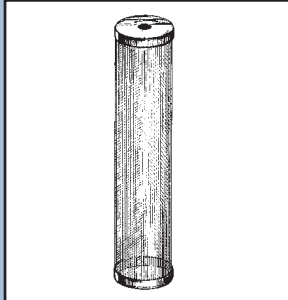

PART NO. 14-2097
REPLACES 730-067

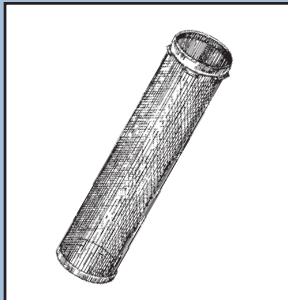

PART NO. 14-2101
REPLACES 761-043

REPLACES TITAN PART NO.	BEDFORD PART NO.	DESCRIPTION
700-897	15-2137	Teflon O-Ring
701-031	7-888	Air Valve Packing
702-130	20-2208	Packing Kit - 440e, 447ex, 660ex, 690gx
702-140	20-2209	Rebuild Kit - 440e, 447ex, 660ex, 690gx
702-303	15-2528	Teflon O-Ring
704-089	—	Replaced by 704-560 (57-2720)
704-090	—	Replaced by 704-560 (57-2720)
704-109	0-2887	O-Ring, Solvent Resistant
704-113	20-2397	Kit - Epic 300HP
704-121	0-2448	O-Ring
704-289	44-2738	Bushing, Piston Guide
704-297	15-2762	Teflon O-Ring
704-547A	49-2728	Lower Packing Assembly
704-551A	57-2700	Rod - Epic Pumps, 440ix, 660ix
704-552A	—	Replaced by 704-560 (57-2720)
704-557	46-2692	Ball Cage, Outlet Valve
704-558	58-2691	Outlet Valve Seat
704-560	57-2720	Piston Rod Assembly - Epic Pumps
704-564	49-2729	Upper Packing Assembly & Tool
704-584	—	Replaced by 762-057 (15-2122)
704-586	20-2727	Kit - 440ix, 640ix, 660ix
704-587	12-2693	Retainer, Outlet Valve Seat
704-642	—	Order as: 704-557 (46-2692) Plastic Cage
704-703	44-3006	Inlet Ball Cage, stainless steel
705-103	44-2809	Adapter
705-105	44-2811	Guide, Piston
705-120A	57-2780	Rod Assy - 740i, 740ix, PowrLiner 2800M
710-046A	14-2082	Inlet Screen - E15, E20, G40, G55, PM5500
710-069	—	Replaced by 227-027 (12-2138)
710-196	0-2139	O-Ring
711-605	8-2148	Tip Gasket, 1/16"
711-606	20-2149	Tip Gasket, 1/16" (12 pcs)
711-611	8-2156	Tip Gasket, 1/8"
711-612A	20-2157	Tip Gasket, 1/8" (12 pcs)
730-067	14-2097	Outlet Filter, 60M - 660ex, 690gx, Pro 690
730-067-10	14-2098	Outlet Filter, 100M - 660ex, 690gx, Pro 690
730-067-30	14-2096	Outlet Filter, 30M - 660ex, 690gx, Pro 690
730-401	20-2242	Kit - 440HP, 447HP, 660HPx
730-506	—	Replaced by 704-560 (57-2720)
730-509	—	Replaced by 704-289 (44-2738)
730-510	—	Replaced by 704-703 (44-3006)
738-004	10-1207	Gasket
738-021	0-1192	O-Ring
738-213	23-1197	Trip Spring
738-224	0-1216	O-Ring
742-001	0-1195	O-Ring
742-051	20-1218	Air Motor Kit - Cmdr 30/60, PowrMastic
742-223	0-563	Valve Sleeve O-Ring
753-024	22-539	Teflon Sealant Tape
757-105	23-3129	Support Spring, Outlet Filter
761-043	14-2101	Outlet Filter, 60 Mesh - E15, E20, G40, G55
761-057	15-2112	Teflon O-Ring
761-058	15-2113	Teflon O-Ring
761-072	49-2342	Upper Packing with Installation Tool
761-076	8-2140	Lower Seal

BEDFORD® Replacement Parts

For . . . TITAN / WAGNER / SPEEFLO

To order, contact your local
Paint Spray Equipment Dealer and ask for
Genuine Bedford Replacement Parts.

REPLACES TITAN PART NO.	BEDFORD PART NO.	DESCRIPTION
761-079	20-2115	Upper Seat & O-Ring - E20, G55, PM5500
761-080	20-2117	Lower Seat & O-Ring - E20, G55, PM5500
761-103	15-2118	Teflon O-Ring
761-111	8-2141	Upper Seal
761-136A	49-2193	Upper Packing Assembly
761-138A	49-2196	Lower Seal - E20, G55, Promark 5500
761-144	9-2119	Ball, Upper
761-145	9-2120	Ball, Lower
761-175	20-2210	Kit - E20, G55, Promark 5500
761-247	23-2142	Core, Filter Manifold
761-273	21-2204	Piston Guide Tool
761-456	15-2121	Teflon O-Ring
762-057	15-2122	Teflon O-Ring
762-058	15-2123	Teflon O-Ring
762-072	49-2338	Upper Packing with Installation Tool
762-076	8-2143	Lower Seal
762-080	20-2127	Lower Seat & O-Ring - E15, G40
762-103	15-2128	Teflon O-Ring
762-111	8-2144	Upper Seal
762-136	—	Replaced by 762-072 (49-2338)
762-137	58-2437	Intake Valve Seat
762-138A	49-2202	Lower Seal - E15, G40
762-144	9-2129	Ball, Outlet
762-145	9-2130	Ball, Lower
762-175	20-2211	Kit - E15, G40
762-273	21-2205	Piston Guide Tool - E15, G40
770-389	20-2150	O-Ring Packing Kit - HVLP Guns
770-401	0-2145	O-Ring
770-402	0-2146	O-Ring
770-410	0-2147	O-Ring
770-584	54-85	Cup Gasket, White Plastic
800-241	20-2776	Intake Seat & O-Ring - 740i/ix, 840i/ix, 1140i/ix
800-242	9-2815	Ball
800-243	58-2761	Seat, Piston Valve - 740ix, 840ix, 1140ix
800-244	44-2823	Outlet Ball Cage
800-245	8-2801	Washer
800-246	57-2820	Rod - Epic 840i, 840ix, Epic 1140i, 1140ix
800-247	9-2802	Ball
800-248	49-2847	Upper Packing Assembly & Tool
800-250	49-2848	Lower Packing Assembly & Tool
800-273	20-2849	Kit - 740/840/1140 Impact, 740ix/840ix/1140ix
800-301	—	Replaced by 0507732 (57-2822)
800-327	8-2846	Spacer
800-332	0-2838	O-Ring
800-333	6-2844	Backup Ring
800-336	44-2803	Retainer, Outlet Valve
800-348	8-2804	Upper Seal, Outlet Valve
800-353	—	Replaced by 800-353A (49-2847)
800-353A	49-2847	Upper Packing Assembly & Tool
800-354	8-2845	Wear Ring
800-355	—	Replaced by 800-255A (49-2848)
800-355A	49-2848	Lower Packing Assembly & Tool
800-365A	57-2826	Rod Assembly - Epic 840i/ix, Epic 1140i/ix
800-441	44-2805	Outlet Ball Cage
800-450	20-2810	Kit - Epic 740i, 740ix, PowrLiner 2800M



PART NO. 14-2265	50M
REPLACES 920-004	
PART NO. 14-2266	100M
REPLACES 930-005	

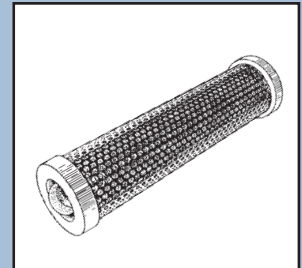

PART NO. 14-2344	5M
REPLACES 930-005	
PART NO. 14-2346	50M
REPLACES 930-006	
PART NO. 14-2347	100M
REPLACES 930-007	

To order, contact your local
Paint Spray Equipment Dealer and ask for
Genuine Bedford Replacement Parts.

BEDFORD® Replacement Parts For . . . TITAN / WAGNER / SPEEFLO

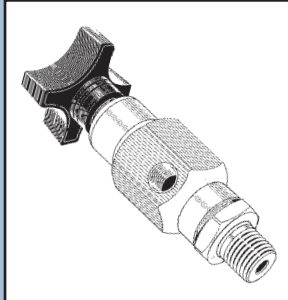

PART NO. 29-2580
REPLACES 944-620

REPLACES TITAN PART NO.	BEDFORD PART NO.	DESCRIPTION
800-451	—	Replaced by 705-120A (57-2780)
800-452	57-2800	Rod - 740i, 740ix, PowrLiner 2800M
800-454	49-2817	Upper Packing Assembly
800-456	49-2818	Lower Packing Assembly
800-906	15-2744	Teflon O-Ring
800-915	29-2835	Bypass Valve Assy, Solvent Resistant O-Ring
800-923	20-2816	Seal Kit, Transducer
800-925	—	Order as: 700-258 (29-2600)
801-054	8-655	Nylon Washer
805-1010	20-3020	Kit - 740/840/1140 Impact, 840ix/1140ix
805-235A	57-3038	Rod Assembly - 740 Impact, 840 Impact
805-437A	57-3040	Rod - 740 Impact, 840 Impact
805-544	8-3188	Spacer
806-091	10-2715	Spacer, Backup Washer
812-003	12-229	Nipple 1/4" NPT x 3/8" NPT
850-004	10-1208	Gasket
850-016	0-1194	O-Ring
850-050	20-1219	Air Motor Kit - Admiral, Cmndr 40, Alaskan
858-811	19-2447	Locknut
858-812	19-1217	Nut
872-005	8-1657	Gasket
891-193	15-2589	Teflon O-Ring
891-403	15-2394	Teflon O-Ring
892-281	0-2382	O-Ring
892-323	15-2395	Teflon O-Ring
911-025	55-874	Needle Valve Packing Set
911-125	55-1220	Needle Valve Packing Set
911-225	6-873	Packing Ring
912-001	7-3027	Leather Washer
916-007	—	Replaced by 569-021 (9-654)
920-004	14-2265	Outlet Filter - 50 Mesh
920-005	14-2266	Outlet Filter - 100 Mesh
920-006	6-2063	Gasket, Outlet Filter (Thick)
920-050	20-2449	Filter Service Kit - 920 Series Filter
920-070	6-2064	Gasket, Outlet Filter (Thin)
920-103	9-479	Ball
920-113	—	Replaced by 920-103 (9-479)
930-005	14-2344	Outlet Filter Element with Ball - 5 Mesh
930-006	14-2346	Outlet Filter Element with Ball - 50 Mesh
930-007	14-2347	Outlet Filter Element with Ball - 100 Mesh
930-020	23-2588	Spring
930-050	20-2586	Service Kit - 930 Series Outlet Manifold Filter
944-000	20-2855	Kit - 944-030 Bleed Valve (Seals & Ball)
944-004	15-2522	Teflon O-Ring
944-023	44-2578	Stem, Dump Valve
944-026	44-2579	Stem Stop, Dump Valve
944-028	—	Replaced by 944-620 (29-2580)
944-038	0-2850	O-Ring
944-042	0-2852	O-Ring
944-043	58-2853	Seat, Carbide
944-044	8-2854	Seal
944-050	20-2520	Valve Service Kit - 944-620 Bleed Valve
944-620	29-2580	Outlet Bleed Valve, 1/4" NPT(m) x 1/8" NPT(f)
944-904	58-2582	Valve Seat, 1/4" NPT(m)
945-003	10-2523	Gasket

BEDFORD® Replacement Parts For . . . INTERNATIONAL PUMP MFG

To order, contact your local
Paint Spray Equipment Dealer and ask for
Genuine Bedford Replacement Parts.

REPLACES IPM PART NO.	BEDFORD PART NO.	DESCRIPTION
02-102-596	—	Replaced by 500213 (15-3165)
02-108-357	—	Replaced by 500141 (0-3162)
02-108-358	—	Replaced by 500144 (0-3163)
02-156-698	—	Replaced by 500206 (0-3164)
02-158-109	—	Replaced by 500236 (0-3170)
02-161-793	—	Replaced by 500227 (4-3168)
02-166-612	—	Replaced by 500248 (15-3172)
02-186-647	—	Replaced by 500222 (42-3167)
02-186-648	—	Replaced by 500228 (42-3169)
02-990-032	—	Replaced by 500237 (0-3171)
02-990-038	—	Replaced by 500066 (0-3161)
02-990-052	—	Replaced by 601013 (20-3174)
02-990-053	—	Replaced by 601011 (20-3173)
500066	0-3161	O-Ring
500141	0-3162	O-Ring
500144	0-3163	O-Ring
500206	0-3164	O-Ring
500213	15-3165	Teflon O-Ring
500221	4-3166	Teflon Cup Packing
500222	42-3167	Bearing
500227	4-3168	Teflon Cup Packing
500228	42-3169	Bearing
500236	5-3170	Gasket
500237	0-3171	O-Ring
500248	15-3172	Teflon O-Ring
601011	20-3173	Kit - IP02 Air Motor
601013	20-3174	Kit - IP02 Fluid Section

BEDFORD® Replacement Parts QUART SIPHON CUP ASSEMBLIES

To order, contact your local
Paint Spray Equipment Dealer and ask for
Genuine Bedford Replacement Parts.

BEDFORD Quart Siphon Cup Assembly comes complete with sturdy aluminum cup and 3/8" NPS female swivel nut connection that fits most guns.

Available in Standard and Non-Drip models with exclusive directional vent tube.

Individually boxed.

REPLACES BINKS PART NO.	BEDFORD PART NO.	DESCRIPTION
81-550	45-1255	Standard Unit (Complete Assembly)
81-350	45-1235	Non-Drip Unit (Complete Assembly)
82-47	45-899	Quart Cup (Fits both units)
82-467	54-7	Gasket, Leather (as supplied with units)
82-56	54-55	Gasket, White Foam
—	13-250	Vent Tube Assembly

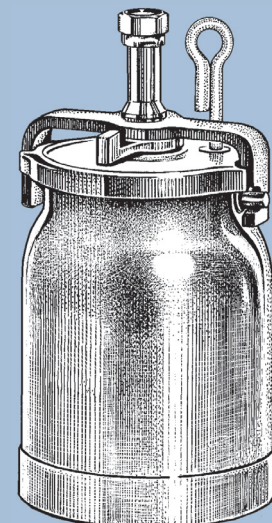

Non-Drip Quart
Siphon Cup Assembly

To order, contact your local
Paint Spray Equipment Dealer and ask for
Genuine Bedford Replacement Parts.

BEDFORD® Replacement Parts

REVERSIBLE AIRLESS SPRAY TIPS

Reversible Airless Spray Tips & Guards

Tips fit most manufacturer's Graco RAC5 / Titan SC-6 compatible guards

- Professional Quality
 - 5000 PSI (345 BAR)
 - Long Service Life
 - 100% Made in the USA
 - Tips Shipped Complete with Solvent Resistant Seat & Seal
- For Use With All Paints

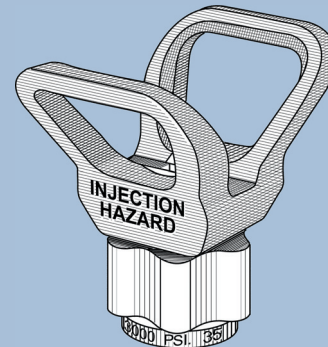
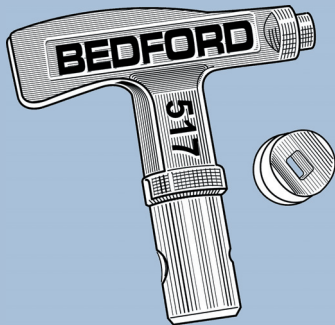

REVERSIBLE TIP

with seat & seal

Replaces
Graco 286-xxx RAC5
& Titan 662-xxx SC-6

P/N 33-7xxx
(see chart below)

TIP RETAINER & GUARD

7/8" & 11/16" Thread, Hand-Tight

Replaces
Graco 243-161 & 243-263
Titan 661-012 & 661-015

P/N 33-7000 P/N 33-7002
G-Thread 7/8" F-Thread 11/16"

SEAT & SEAL

5-Pack

Replaces
Graco 243-281

P/N 33-7001

Bedford Tip P/N Selection Chart

Orifice Size (inches)	Flow Rate (gpm)	Fan Width (inches / cm)						
		4" - 6" (10 - 15 cm)	6" - 8" (15 - 20 cm)	8" - 10" (20 - 25.5 cm)	10" - 12" (25.5 - 30.5 cm)	12" - 14" (30.5 - 35.5 cm)	14" - 16" (35.5 - 40.6 cm)	16" - 18" (40.6 - 45.7 cm)
.007	.05	33-7207						
.009	.09	33-7209	33-7309					
.011	.12	33-7211	33-7311	33-7411	33-7511			
.013	.18	33-7213	33-7313	33-7413	33-7513			
.015	.24	33-7215	33-7315	33-7415	33-7515	33-7615		
.017	.31	33-7217	33-7317	33-7417	33-7517	33-7617	33-7717	
.019	.38	33-7219	33-7319	33-7419	33-7519	33-7619		33-7819
.021	.47		33-7321	33-7421	33-7521	33-7621	33-7721	
.023	.57		33-7323	33-7423	33-7523	33-7623	33-7723	
.025	.67		33-7325	33-7425	33-7525	33-7625	33-7725	
.027	.77		33-7327	33-7427	33-7527	33-7627		
.029	.90			33-7429	33-7529	33-7629		
.031	1.03			33-7431	33-7531	33-7631		
.033	1.17			33-7435		33-7633		
.035	1.31				33-7535	33-7635		

BEDFORD® Replacement Parts

PAINT STRAINERS

To order, contact your local Paint Spray Equipment Dealer and ask for Genuine Bedford Replacement Parts.

- 60 Mesh fabric
- Specially woven for straining
- Resistant to paint solvents
- Stops spray gun clogging

2 Sizes...

SIZE	PACKED 12 / POLY BAG
	BEDFORD PART NO.
1 GALLON	14-516
5 GALLON	14-517

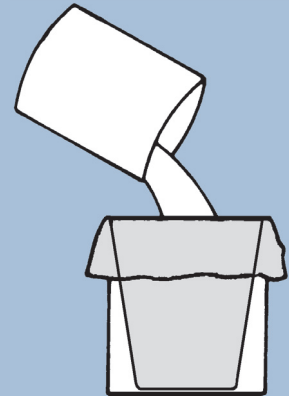



BEDFORD® Replacement Parts

DISPOSABLE PROTECTIVE CLOTHING

To order, contact your local Paint Spray Equipment Dealer and ask for Genuine Bedford Replacement Parts.

	FABRIC STRETCH SOCK		
	ONE SIZE FITS ALL INDIVIDUALLY PACKED	SIZE	PART NO.
		ONE SIZE FITS ALL	41-1497

	TYVEK® HOODS		
	ONE SIZE FITS ALL PACKED 12 / POLY BAG	SIZE	PART NO.
		ONE SIZE FITS ALL	41-898

	TYVEK® SHIRTS		
	SNAP CLOSURE TWO SIZES INDIVIDUALLY PACKED	SIZE	PART NO.
		LARGE	41-1271
		X-LARGE	41-1272

	TYVEK® PANTS		
	ELASTIC WAIST TWO SIZES INDIVIDUALLY PACKED	SIZE	PART NO.
		LARGE	41-1273
		X-LARGE	41-1274

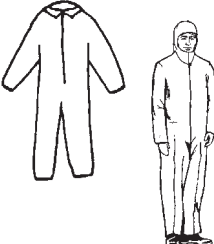
	TYVEK® COVERALLS			
	ZIPPER FRONT CLOSURE THREE SIZES INDIVIDUALLY PACKED HOODED AVAILABLE	HOODED	SIZE	PART NO.
		NO	LARGE	41-901
		NO	X-LARGE	41-964
		NO	XX-LARGE	41-928
		YES	LARGE	41-2921
		YES	X-LARGE	41-2922
		YES	XX-LARGE	41-2923

To order, contact your local
Paint Spray Equipment Dealer and ask for
Genuine Bedford Replacement Parts.

BEDFORD® Replacement Parts TANK & CUP LID GASKETS

Manufactured from the highest quality Thiokol, Stratoprene, Rubber, Leather and Plastic compounds combining the best possible solvent resisting and elastic properties for maximum seal and long life. Thiokol gaskets provide maximum solvent resistance. More economical Stratoprene gaskets provide moderate solvent resistance and are excellent when used with water based materials.

TANK-LID GASKETS



O.E.M.	SIZE	REPLACES O.E.M. PART NO.	MATERIAL	BEDFORD PART NO.
BINKS	2 Gallon	83-1419	Stratoprene	56-90
	5 Gallon	83-1420	Stratoprene	56-91
	10, 15 Gallon	83-1421	Stratoprene	56-92
DEVILBISS	2-1/2 Gallon	PT-33-1	Stratoprene	56-97
	5, 15 Gallon	QM-1458-1	Stratoprene	56-98
	2 Gallon	QM-1462	Stratoprene	56-93
	2 Gallon	QMS-67	Stratoprene	56-94
	2-1/2 Gallon	QMS-80-1	Stratoprene	56-95

CUP-LID GASKETS

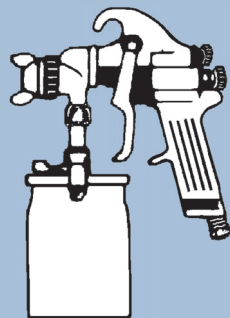

REPLACES		DESCRIPTION	BEDFORD PART NO.
O.E.M.	PART NO.		
BINKS	56-730	Model 35 Gun, Thiokol	54-32
	80-11	1 & 2 Qt Pressure Cup, White Plastic	54-81
	80-45	1 & 2 Quart Pressure Cup, Leather	54-45
	82-56	1 Quart Siphon Cup, White Plastic	54-55
	82-467	1 Quart Siphon Cup, Leather	54-7
DEVILBISS	C-39-K5	White Plastic (5-pack)	55-71
	KR-11-K5	White Plastic (5-pack)	55-74
	TGC-9-K5	White Plastic (5-pack)	55-87
TITAN	770-584	White Plastic	54-85
WAGNER	275520	White Plastic	54-84

BEDFORD® Replacement Parts

HIGH PRESSURE VALVES

To order, contact your local
Paint Spray Equipment Dealer and ask for
Genuine Bedford Replacement Parts.

GRACO HIGH PRESSURE BALL VALVES

5000 PSI MAXIMUM WORKING PRESSURE

REPLACES GRACO PART NO.	BEDFORD PART NO.	DESCRIPTION Inlet x Outlet (under handle)
210-657	29-1440	1/4" NPT(m) x 1/4" NPT(m) with Viton Seals
210-658	29-1441	3/8" NPT(m) x 3/8" NPT(m) with Viton Seals
210-659	29-1442	3/8" NPT(m) x 1/4" NPT(m) with Viton Seals
214-037	29-1443	1/4" NPT(m) x 1/4" NPT(m) with Teflon Seals
223-959	29-1791	3/8" NPT(m) x 1/4" NPT(m) with Teflon Seals
223-960	29-1504	3/8" NPT(m) x 3/8" NPT(m) with Teflon Seals
217-559	20-1259	Ball Valve Repair Kit - Viton Contains: Valve Ball, Seats & Viton Seals
217-560	20-1260	Ball Valve Repair Kit - Teflon Contains: Valve Ball, Seats & Teflon Seals

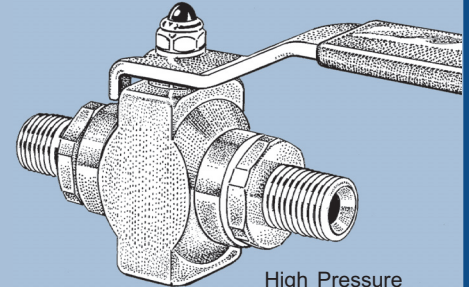

High Pressure
Ball Valve

TITAN / SPEEFLO NEEDLE DUMP VALVE

5000 PSI MAXIMUM WORKING PRESSURE

REPLACES SPEEFLO PART NO.	BEDFORD PART NO.	DESCRIPTION
944-620	29-2580	1/4" NPT(m) Inlet x 1/8" NPT(f) Outlet

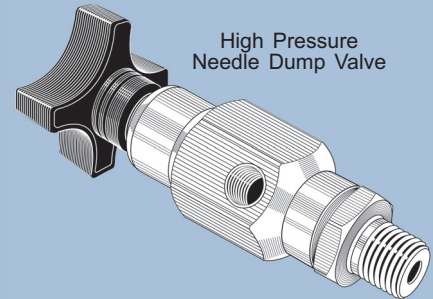

High Pressure
Needle Dump Valve

GRACO THUMB-SCREW NEEDLE DUMP VALVES

5000 PSI MAXIMUM WORKING PRESSURE

REPLACES GRACO PART NO.	BEDFORD PART NO.	DESCRIPTION
222-198	29-1974	1/4" NPT(m) Inlet Connection
224-775	29-2630	1/8" NPT(f) Inlet x 1/8" NPT(f) Outlet, Bare Valve
235-198	20-2078	Dump Valve Repair Kit - Contains: Stem Assembly, Ball, Carbide Seat, Gasket

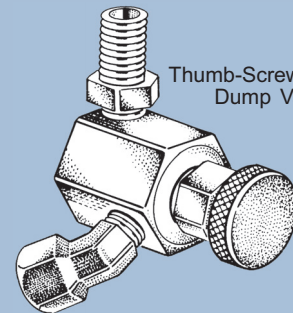

Thumb-Screw Needle
Dump Valve

GRACO HIGH PRESSURE NEEDLE BLEED VALVE

5000 PSI MAXIMUM WORKING PRESSURE

REPLACES GRACO PART NO.	BEDFORD PART NO.	DESCRIPTION
245-143	29-3150	3/8" NPT(m) Inlet x 1/8" NPT(f) Outlet
245-145	20-3014	Bleed Valve Repair Kit - Includes Ball, Seat, Gasket, Retaining Ring & Teflon O-Ring

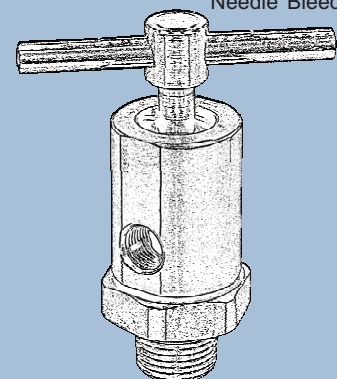

High Pressure
Needle Bleed Valve

To order, contact your local
Paint Spray Equipment Dealer and ask for
Genuine Bedford Replacement Parts.

BEDFORD® Replacement Parts LOW PRESSURE VALVES

GRACO 1/4-TURN DUMP VALVES

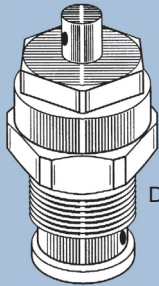

1/4-Turn
Dump Valve

REPLACES GRACO PART NO.	BEDFORD PART NO.	DESCRIPTION
235-014	20-2324	Valve Body Assembly, 3000 PSI
239-914	20-2806	Valve Body Assembly, 3000 PSI, Solvent Resistant
24B-156	29-3160	Heavy Duty Valve Body Assembly, 3300 PSI
287-545	20-3136	Valve Body Assembly - 900 PSI FieldLazer/TurfLazer

TITAN 1/4-TURN PRIME/SPRAY VALVES

3000 PSI MAXIMUM WORKING PRESSURE

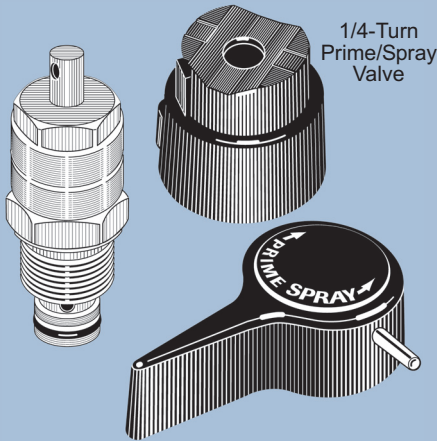

1/4-Turn
Prime/Spray
Valve

REPLACES TITAN PART NO.	BEDFORD PART NO.	DESCRIPTION
700-258	29-2600	Valve Body Assembly, Handle Base, Pin
800-915	29-2835	Valve Body Assembly w/ Solvent Resistant O-Ring

BINKS LOW PRESSURE BALL VALVES

250 PSI MAXIMUM WORKING PRESSURE

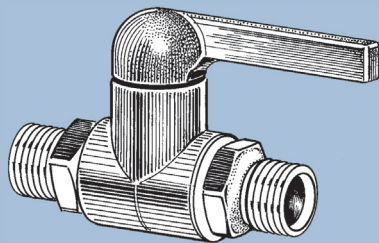

Low Pressure Ball Valve

REPLACES BINKS PART NO.	BEDFORD PART NO.	FITTING CONFIGURATION Outlet (under handle) x Inlet
72-81611	29-1570	1/4" NPS(m) x 1/4" NPT(m)
72-81712	29-1571	3/8" NPS(m) x 3/8" NPT(m)
72-81612	29-1672	1/4" NPS(m) x 3/8" NPT(m)
72-81216	29-1693	3/8" NPT(m) x 1/4" NPS(m)
72-81711	29-1694	3/8" NPS(m) x 1/4" NPT(m)
72-81212	29-2375	3/8" NPT(m) x 3/8" NPT(m)
72-83030	29-2575	1/4" NPT(m) x 1/4" NPT(m)
72-84030	29-2601	3/8" NPT(m) x 1/4" NPT(m)
72-84040	29-2576	3/8" NPT(m) x 3/8" NPT(m)
83-2600	6-982	Replacement Teflon Seal (2 required per valve)

BINKS AIR METERING "CHEATER" VALVE

125 PSI MAXIMUM WORKING PRESSURE

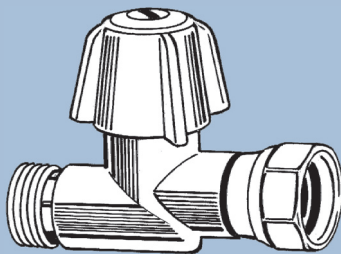

Air Metering "Cheater" Valve

REPLACES BINKS PART NO.	BEDFORD PART NO.	DESCRIPTION
73-157	29-1680	1/4" NPS(m) x 1/4" NPS(f)

BEDFORD® Replacement Parts

LOW PRESSURE BULK HOSE

To order, contact your local
Paint Spray Equipment Dealer and ask for
Genuine Bedford Replacement Parts.

LOW PRESSURE BULK HOSE

AIR HOSE

- Red Cover
- Full Reels: 600'-750'
- Maximum Working Pressure: 250 PSI
- Maximum 3 Pieces per Reel (Random Lengths)

DIMENSIONS		NO. BRAIDS	TUBE	COVER	REPLACES PART NO.			BEDFORD FULL REEL	BEDFORD CUT LENGTH
I.D.	O.D.				BINKS	DEVILBISS	GRACO	PART NO.	PART NO.
1/4"	1/2"	1	Buna-N	Smooth	71-10000	H1957-1	061-204	13-4	13-64
5/16"	5/8"	1	Buna-N	Corrugated	—	H1901-1	—	13-57	13-77
5/16"	5/8"	1	Buna-N	Smooth	71-11000	H1921-1	061-207	13-59	13-79
3/8"	11/16"	1	Buna-N	Smooth	71-12000	H1958-1	061-089	13-6	13-66



FLUID HOSE

- Black Neoprene Cover
- Full Reels: 600'-750'
- Maximum Working Pressure: 750 PSI
- Nylon Inner Tube
- Maximum 3 Pieces per Reel (Random Lengths)
- Temperature Range: -40°F to +190°F

DIMENSIONS		NO. BRAIDS	TUBE	COVER	REPLACES PART NO.			BEDFORD FULL REEL	BEDFORD CUT LENGTH
I.D.	O.D.				BINKS	DEVILBISS	GRACO	PART NO.	PART NO.
1/4"	1/2"	1	Nylon	Neoprene	71-280	H1975-1	061-205	13-470	13-1170
3/8"	11/16"	1	Nylon	Neoprene	71-282	H1973-1	061-195	13-480	13-1180
1/2"	7/8"	2	Nylon	Neoprene	71-283	H1974-1	061-200	13-1010	13-1110
3/4"	1-3/16"	2	Nylon	Neoprene	71-284	—	061-185	13-490	13-1190
1"	1-1/2"	2	Nylon	Neoprene	71-285	—	061-188	13-2550	—

LOW PRESSURE REUSABLE HOSE CONNECTIONS

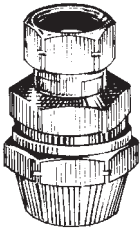
- Plated Brass
- 30° Seat

	BEDFORD PART NO.	REPLACEMENT FOR:			HOSE SIZE ID x OD	THREAD
		BINKS PART NO.	DEVILBISS PART NO.	GRACO PART NO.		
	12-304	72-1303	P-HC-4523	104-415	1/4" x 1/2"	1/4" NPS(F) Swivel
	12-306	72-1306	P-HC-4543	104-084	1/4" x 1/2"	3/8" NPS(F) Swivel
	12-301	72-1317	P-HC-4527	103-605	5/16" x 5/8"	1/4" NPS(F) Swivel
	12-305	72-1478	P-HC-4599	—	5/16" x 5/8"	1/4" NPT(M)
	12-302	72-1328	P-HC-4548	104-414	3/8" x 11/16"	3/8" NPS(F) Swivel
	12-303	72-1325	P-HC-4528	—	3/8" x 11/16"	1/4" NPS(F) Swivel
	12-368	72-1333	P-HC-4551	101-201	1/2" x 7/8"	3/8" NPS(F) Swivel
	BEDFORD PART NO.	REPLACEMENT FOR:		COMPRESSION RING FOR CONNECTOR PART NO.		
		BINKS PART NO.	GRACO PART NO.			
	12-310	72-854	104-412	12-304, 12-306		
	12-311	72-855	—	12-301, 12-305		
	12-312	72-856	104-413	12-302, 12-303		
	12-313	—	—	12-368		

To order, contact your local
Paint Spray Equipment Dealer and ask for
Genuine Bedford Replacement Parts.

BEDFORD® Replacement Parts HOSE ASSEMBLIES

LOW PRESSURE AIR & FLUID HOSE ASSEMBLIES

BULK HOSE NO.	HOSE I.D.	FITTING - THREAD	ASSEMBLY LENGTH					
			15'	25'	50'		75'	100'
			P/N	P/N	P/N	PRICE	P/N	P/N
AIR HOSE ASSEMBLIES								
13-4	1/4	12-304 - 1/4 NPS(F)	13-520	13-521	13-522	59.36	13-523	13-524
13-57	5/16 C	12-301 - 1/4 NPS(F)	13-362	13-358	13-359	66.50	13-360	13-361
13-59	5/16 S	12-301 - 1/4 NPS(F)	13-366	13-354	13-355	66.50	13-356	13-357
13-6	3/8	12-302 - 3/8 NPS(F)	13-529	13-525	13-526	68.38	13-527	13-528
FLUID HOSE ASSEMBLIES								
13-470	1/4	12-306 - 3/8 NPS(F)	13-475	13-471	13-472	89.62	13-473	13-474
13-480	3/8	12-302 - 3/8 NPS(F)	13-485	13-481	13-482	107.38	13-483	13-484
13-1010	1/2	12-368 - 3/8 NPS(F)	13-1015	13-1011	13-1012	155.46	13-1013	13-1014
13-490	3/4	*12-429 - 3/4 NPT(M)	13-498	13-494	13-495	253.00	13-496	13-497

* Permanent factory-installed fittings

SUCTION HOSE ASSEMBLIES

HOSE I.D.	LENGTH	BEDFORD PART NO.	CONNECTOR THREAD INSTALLED
3/4"	3'	13-499	Hose Only (no fittings)
3/4"	3-1/2'	13-491	3/4" NPT(m) x 3/4" NPT(m)
3/4"	6'	13-492	3/4" NPT(m) x 3/4" NPT(m)
1"	4'	13-2557	Hose Only (no fittings)
1"	5'	13-2558	Hose Only (no fittings)
1"	6'	13-2556	1" NPT(m) Rigid x 1" NPT(m) Swivel

PRESSURE WASHER HOSE ASSEMBLIES

- Non-Marking Cover
- Heavy Duty Bend Restrictors
- Rated for Intermittent Use up to 250°F.
- 3/8" ID Rubber Tube / Wire Braided

3/8" PRESSURE WASHER HOSE ASSEMBLIES

LENGTH	PRESSURE RATING (PSI)	BEDFORD PART NO.	CONNECTIONS / FITTINGS
50'	4000	13-2542	3/8" NPT(m) Rigid x 3/8" NPT(m) Swivel
50'	4000	13-2543	With Quick Disconnect Coupler & Plug Installed

PRESSURE WASHER QUICK DISCONNECT FITTINGS

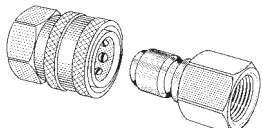
	BEDFORD PART NO.	DESCRIPTION
	12-2524	Plug - 3/8" NPT(f), Stainless Steel
	12-2525	Plug - 3/8" NPT(f), Plated Steel
	12-2526	Coupler - 3/8" NPT(f), Brass
	12-2527	Coupler - 3/8" NPT(f), Stainless Steel

AIRLESS HOSE ASSEMBLIES

Airless hose assemblies are conductive for static grounding and are 100% inspected for conductivity. Synthetic braid gives hose accumulator effect to prevent damage to pumps. Hose has a blue abrasion resistant polyurethane cover and a nylon tube. Temperature range: 0°F to +180°F.

3/16" AIRLESS HOSE ASSEMBLIES 3,500 PSI WORKING PRESSURE

Supplied with fittings as shown, and spring guards on both ends.

LENGTH	BEDFORD PART NO.	FITTINGS INSTALLED	REPLACEMENT FOR:		
			GRACO PART NO.	BINKS PART NO.	WAGNER PART NO.
2'	13-791	1/4"(M) x 1/4"(F)	214-700	—	—
3'	13-792	1/4"(M) x 1/4"(F)	214-701 / 238-358	—	—
5'	13-798	1/4"(M) x 1/4"(F)	—	71-8085	88600
6'	13-793	1/4"(M) x 1/4"(F)	214-699 / 238-359	—	—
10'	13-794	1/4"(M) x 1/4"(F)	—	71-8086	—
15'	13-795	1/4"(F) x 1/4"(F)	214-981	71-8087	—
25'	13-796	1/4"(F) x 1/4"(F)	214-698	71-8088	153000
50'	13-797	1/4"(F) x 1/4"(F)	214-697	71-8089	153001

1/4" AIRLESS HOSE ASSEMBLIES 3,300 PSI WORKING PRESSURE

Supplied with 1/4" NPS female fittings, and spring guards on both ends.

LENGTH	BEDFORD PART NO.	REPLACEMENT FOR:		
		GRACO PART NO.	BINKS PART NO.	WAGNER PART NO.
2-1/2'	13-1855	223-766	—	—
7'	13-3180	245-798	—	—
25'	13-931	223-540 / 240-793	71-7704	154014
50'	13-932	223-541 / 240-794	71-7705	154015

3/8" AIRLESS HOSE ASSEMBLIES 3,300 PSI WORKING PRESSURE

Supplied with 3/8" NPS female fittings and spring guards on both ends.

LENGTH	BEDFORD PART NO.	REPLACEMENT FOR:			
		GRACO PART NO.	BINKS PART NO.	SPEEFLO PART NO.	WAGNER PART NO.
3'	13-3226	245-797	—	—	—
25'	13-451	214-703 / 240-796	71-8424	225-038	88003
50'	13-453	214-705 / 240-797	71-8425	250-038	88004

To order, contact your local
Paint Spray Equipment Dealer and ask for
Genuine Bedford Replacement Parts.

BEDFORD® Replacement Parts FITTINGS & ADAPTERS

QUICK DISCONNECTS - Automatic Type - 250 PSI - For Air and Water

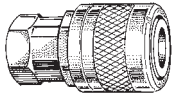
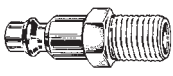
1330 SERIES	BEDFORD PART NO.	THREAD	INTERCHANGES WITH:				
			GRACO NO.	PARKER NO.	MILTON NO.	ALEMITE NO.	ARO NO.
	12-1330	1/4" NPT(f)	208-536	23 / 43	715	328030	23002-200
	12-1331	1/4" NPT(m)	—	22 / 42	716	330604	23002-212
	12-1332	1/4" NPT(f)	169-967	H3C	728	330605	23902-200
	12-1333	1/4" NPT(m)	169-970	H2C	727	328034	23902-210
	12-1334	3/8" NPT(m)	169-971	H2C-E	733	—	23902-310

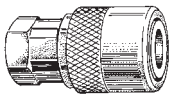
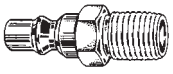
1340 SERIES	BEDFORD PART NO.	THREAD	INTERCHANGES WITH:				
			GRACO NO.	PARKER NO.	MILTON NO.	ALEMITE NO.	ARO NO.
	12-1340	1/4" NPT(f)	—	53	775	—	210
	12-1341	1/4" NPT(m)	—	52	—	—	210-212
	12-1342	1/4" NPT(f)	—	A3C	778	—	2609
	12-1343	1/4" NPT(m)	—	A2C	777	—	2608

QUICK DISCONNECTS - 5000 PSI - For Pressure Washers

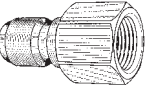
2520 SERIES	BEDFORD PART NO.	THREAD	INTERCHANGES WITH:	DESCRIPTION
			GRACO NO.	
	12-2526	3/8" NPT(f)	801-569	Brass Stainless Steel
	12-2527	3/8" NPT(f)	803-157	
	12-2524	3/8" NPT(f)	801-568	Stainless Steel Plated Steel
	12-2525	3/8" NPT(f)	—	

SWIVEL ADAPTER UNIONS - Plated Steel - High Pressure (5000 PSI)

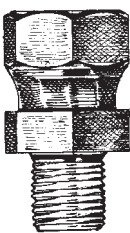
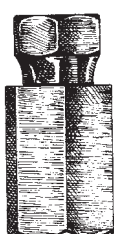
	BEDFORD PART NO.	REPLACEMENT FOR:			DESCRIPTION	
		GRACO PART NO.	BINKS PART NO.	ALEMITE PART NO.	FRONT END	SWIVEL END
	12-402	156-823	41-1412	1000-44	1/4" NPT(m)	1/4" NPS(f)
	12-403	157-705	20-4468	1000-46	1/4" NPT(m)	3/8" NPS(f)
	12-404	154-986	—	1000-64	3/8" NPT(m)	1/4" NPS(f)
	12-405	155-665	20-4281	1000-66	3/8" NPT(m)	3/8" NPS(f)
	12-406	162-505	72-945	1000-68	3/8" NPT(m)	1/2" NPS(f)
	12-407	158-256	20-4067	1000-86	1/2" NPT(m)	3/8" NPS(f)
	12-465	156-684	20-4283	1000-88	1/2" NPT(m)	1/2" NPS(f)
	12-408	157-785	20-4455	—	3/4" NPT(m)	3/4" NPS(f)
	12-418	155-470	—	—	1/2" NPT(m)	1/2" NPS(f)x90°
	12-410	—	—	—	1/8" NPT(f)	1/8" NPS(f)
	12-409	155-570	83-1935	1012-44	1/4" NPT(f)	1/4" NPS(f)
	12-251	156-173	20-4256	1012-66	3/8" NPT(f)	3/8" NPS(f)
	12-411	161-077	20-4276	1012-86	1/2" NPT(f)	3/8" NPS(f)
	12-412	155-865	20-4277	1012-88	1/2" NPT(f)	1/2" NPS(f)
	12-413	156-172	20-4278	1012-1212	3/4" NPT(f)	3/4" NPS(f)
	12-201	157-676	72-918	—	1/4" NPT(f)	1/4" NPS(f)x90°
	12-431	157-416	—	—	1/2" NPT(f)	1/2" NPS(f)x90°
	12-415	156-589	—	—	3/4" NPT(f)	3/4" NPS(f)x90°

BEDFORD® Replacement Parts

FITTINGS & ADAPTERS

To order, contact your local
Paint Spray Equipment Dealer and ask for
Genuine Bedford Replacement Parts.

FULL-TIME LIVE SWIVEL CONNECTIONS - Plated Steel - 3600 PSI WPR

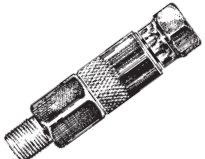
	BEDFORD PART NO.	REPLACES GRACO PART NO.	DESCRIPTION
	12-2400 12-1900	239-663 223-341	Swivel - 1/4" NPS (f) x 1/4" NPT (m) - Leather Packed Swivel - 1/4" NPS (f) x 1/4" NPT (m) - Teflon Packed

ADAPTERS - Brass - Low Pressure (750 PSI)

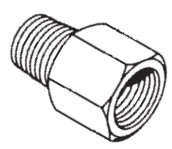
	BEDFORD PART NO.	REPLACEMENT FOR:		DESCRIPTION MALE THREAD x FEMALE THREAD
		BINKS PART NO.	DEVILBISS PART NO.	
12-599	72-55	AD-404	1/4" NPS (m) x 3/8" NPS (f)	

NIPPLES - Brass - Low Pressure (750 PSI) - 30° Seat Both Ends

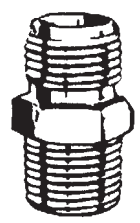
	BEDFORD PART NO.	REPLACEMENT FOR:		DESCRIPTION
		BINKS PART NO.	DEVILBISS PART NO.	
12-224	—	—	1/8" NPS x 1/8" NPS	
12-227	71-28	H-1766	1/8" NPT x 1/4" NPS	
12-221	83-1050	AD-31	1/4" NPS x 1/4" NPS	
12-222	83-576	H-2008	1/4" NPS x 1/4" NPT	
12-225	—	—	1/4" NPS x 3/8" NPS	
12-878	—	H-153	1/4" NPS x 5/8"-18	
12-879	—	H-77	3/8 x 5/8-18	
12-223	83-1294	H-1446	3/8" NPS x 3/8" NPS	

NIPPLES - Plated Steel - High Pressure (5000 PSI) - 30° Seat Both Ends

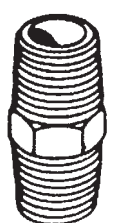
	BEDFORD PART NO.	REPLACEMENT FOR:			DESCRIPTION
		GRACO PART NO.	BINKS PART NO.	WAGNER PART NO.	
12-1978	151-519	—	—	1/8" NPT x 1/4" NPT	
12-228	156-971	—	93896	1/4" NPT x 1/4" NPT	
12-219	162-453	—	—	1/4" NPT x 1/4" NPS	
12-229	157-350	72-995	88162	1/4" NPT x 3/8" NPT	
12-230	156-849	—	88160	3/8" NPT x 3/8" NPT	
12-232	159-239	—	—	3/8" NPT x 1/2" NPT	
12-231	158-491	—	—	1/2" NPT x 1/2" NPT	



PLUGS - Plated Steel

	BEDFORD PART NO.	REPLACEMENT FOR:			DESCRIPTION
		GRACO PART NO.	BINKS PART NO.	DEVILBISS PART NO.	
12-1480	100-403	—	SS-1215	1/8" NPT - Square Head	
12-1481	100-509	86-558	SS-1216	1/4" NPT - Square Head	
12-1482	100-721	20-2288	—	1/4" NPT - Socket Head	
12-2138	—	—	—	1/4" NPT - Hex Head	
12-1483	100-040	20-1592	SS-1217	3/8" NPT - Square Head	

To order, contact your local
Paint Spray Equipment Dealer and ask for
Genuine Bedford Replacement Parts.

BEDFORD® Replacement Parts FILTERS & STRAINERS

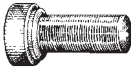
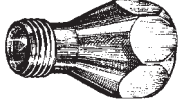
TIP FILTERS, INLINE FILTER, & ACCESSORIES

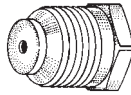

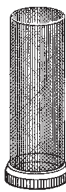

	REPLACES		BEDFORD PART NO.	DESCRIPTION
	OEM	PART NO.		
	Graco	205-264	14-151	Tip Filter, Fine, 100 Mesh
	Graco	205-265	14-152	Tip Filter, Coarse, 60 Mesh
	Binks	54-1835	14-1161	Tip Filter, Fine, 100 Mesh
	Binks	54-1836	14-1162	Tip Filter, Coarse, 60 Mesh
	Graco	164-120	12-620	Tip Filter Housing Stainless Steel, 7/8"(f) - 11/16"(m) Threads (May also be used as an adapter to convert from "G" gun thread to "F" tip base thread)
	Graco	210-500	14-1200	Inline Filter Assembly (Stainless Steel) 1/4" NPS(f) x 1/4" NPS(m) (Includes (1) Fine Tip Filter)
	Graco	181-084	12-1587	Adapter - Binks Gun to Graco Tip Base (3/4"(f) "B" Thread - 7/8"(m) "G" Thread)
	Graco	181-085	12-1486	Adapter - Wagner / Airlessco / ASM Guns to Graco Tip Base (11/16"(f) "F" Thread - 7/8"(m) "G" Thread)

Note: Replacement for Graco 212-058 - Order (1)8-122, (1)12-620, (1)14-151, (1)14-152

AIR & FLUID INLINE STRAINER ELEMENTS

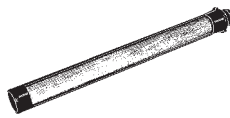
	REPLACES		BEDFORD PART NO.	MESH	DESCRIPTION
	OEM	PART NO.			
	Binks	83-2705	14-1731	30	Filter Element
	Binks	83-2089	14-1732	50	Filter Element
	Binks	83-2596	14-1733	80	Filter Element
	Binks	83-1256	14-1734	100	Filter Element
	Binks	83-2405	14-1735	150	Filter Element
	Binks	83-2706	14-1736	200	Filter Element

AIRLESS GUN FILTERS





	REPLACES		BEDFORD PART NO.	MESH	DESCRIPTION
	OEM	PART NO.			
	Graco	257-129	14-3225	30	Contractor II / FTx II Gun Filter - Gray
	Graco	287-032	14-2664	60	Contractor II / FTx II Gun Filter - Black
	Graco	287-033	14-2665	100	Contractor II / FTx II Gun Filter - Blue
	Graco	287-034	14-2648	60 & 100	Contractor II / FTx II Gun Filters - Twin-Pack
	Graco	218-131	14-1484	50	Contractor Gun Filter Assembly - Coarse
	Graco	218-133	14-1485	100	Contractor Gun Filter Assembly - Fine
	Graco	179-731	14-1118	50	Contractor Gun Filter Element - Coarse
	Graco	179-732	14-1120	100	Contractor Gun Filter Element - Fine
	Wagner	89323	14-831	30	G-10 Gun Filter - Coarse (Green)
	Wagner	34377	14-832	50	G-10 Gun Filter - Medium (White)
	Wagner	89324	14-833	100	G-10 Gun Filter - Fine (Yellow)
	Wagner	34383	14-834	180	G-10 Gun Filter - Extra Fine (Red)
	Titan	500-200-03	14-2171	30	LX-80 Gun Filter, 2-pack - Coarse (Green)
	Titan	500-200-06	14-2172	60	LX-80 Gun Filter, 2-pack - Medium (White)
	Titan	500-200-10	14-2173	100	LX-80 Gun Filter, 2-pack - Fine (Yellow)
	Titan	500-200-15	14-2174	150	LX-80 Gun Filter, 2-pack - Extra Fine (Red)

BEDFORD® Replacement Parts

FILTERS & STRAINERS

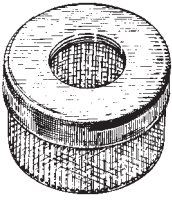
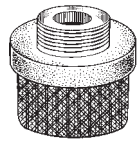
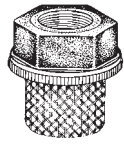
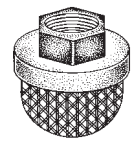
To order, contact your local
Paint Spray Equipment Dealer and ask for
Genuine Bedford Replacement Parts.





INLET STRAINERS ("Rock Catchers")

	REPLACES		BEDFORD PART NO.	MESH	SIZE / DESCRIPTION
	OEM	PART NO.			
	Stainless Steel Cap, Stainless Steel Screen				
	Airlessco	141-008	14-1817	16	3/4" NPT, Double Screen
	Amspray	2975	14-1325	8	3/4" NPT, Single Screen
	Amspray	2976	14-1329	16	3/4" NPT, Double Screen
	Binks	41-10094	14-674	16	3/4" NPT, Double Screen
	Graco/ASM	112-604	14-2779	8	1" NPT, Stainless Steel Cap, Single Screen
	Graco	181-072	14-1223	16	1" NPT, Stainless Steel Cap, Double Screen
	Graco	181-073	14-1224	16	1/2" NPT, Stainless Steel Cap, Double Screen
	Graco	183-770	14-1428	16	3/4" NPT, Stainless Steel Cap, Double Screen
	Graco	189-920	14-2179	8	1" NPT, Single Screen
	H.E.R.O.	187A	14-2332	16	3/4" NPT, Double Screen
	Wagner	88241	14-856	10	Large Metric, Single Screen
	Nylon Cap, Stainless Steel Screen - Order by Bedford P/N:				
	Graco	181-072(P)	14-2353	16	1" NPT, Nylon Cap, Double Screen
Graco	181-073(P)	14-2351	16	1/2" NPT, Nylon Cap, Double Screen	
Graco	183-770(P)	14-2352	16	3/4" NPT, Nylon Cap, Double Screen	
	Graco	243-082	14-2530	36	3/4" Garden Hose Thread for Magnum Pumps
	Graco/ASM	245-578	14-2760	36	3/4" Garden Hose Thread
	Graco	257-002	14-3002	36	3/4" Garden Hose Thread
	Graco	257-566	14-3211	16	3/4" Garden Hose Thread, coarse
	Graco	288-716	14-2843	36	3/4" Garden Hose Thread
	Graco	187-651	14-3064	12	3/4" UNF Thread (replaces Airlessco 331-217)
	Graco	235-004	14-1964	12	3/4" UNF Thread for 390st & Nova SP
	Graco	245-673	14-3054	12	3/4" UNF Thread
	Graco	257-003	14-3003	12	3/4" UNF Thread
	Graco/ASM	276-897	14-2759	12	7/8" UNF Thread
	Graco	246-385	14-2649	12	7/8" UNF Thread for Ultra 395/495 Pumps
	Titan	700-805	14-2081	10	3/4" UNF Thread for all Epic Series Pumps
	Titan	710-046A	14-2082	10	1-5/16" UNF Thread for all Elite Series Pumps
	Wagner	0295565	14-2870	16	3/4" UNF Thread for EP/EPX Pumps
	Wagner	5006536	14-2682	10	1-5/16" UNF Thread for EPX/GPX Pumps
	Graco	207-241	14-700	60	Wire Cage & Bag for 3/4" OD Tube
	Graco	210-726	14-900	60	Wire Cage & Bag for 1-1/4" OD Tube
	Graco	207-240	14-370	60	Replacement Filter Bags (12-Pack)
	Graco	238-769	14-2170	60	Replacement Filter Bags (25-Pack)
	Speeflo	103-625	14-2297	10	Inlet Strainer Assembly for 1" OD Tube
	Speeflo	103-627	14-2299	10	Inlet Strainer Assembly for 1-1/4" OD Tube
	Wagner	509762A	14-2748	10	Inlet Strainer Assembly for 1-1/4" OD Tube
	Graco	288-472	14-3134	10	Inlet Filter Element - inserts into pickup tube

To order, contact your local
Paint Spray Equipment Dealer and ask for
Genuine Bedford Replacement Parts.

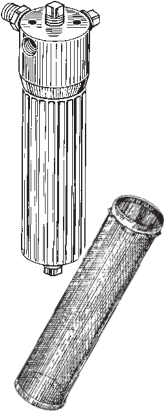
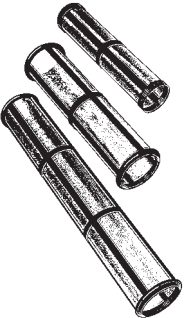
BEDFORD® Replacement Parts FILTERS & STRAINERS

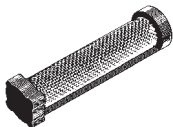
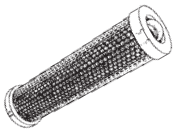
FLUID OUTLET MANIFOLD ASSEMBLY & OUTLET FILTERS

	REPLACES		BEDFORD PART NO.	MESH	DESCRIPTION
	OEM	PART NO.			
	Graco	214-570	14-1566	60	Fluid Outlet Manifold Filter - Complete Assembly
	Amspray	4339	14-1489	50	Fluid Outlet Strainer
	Amspray	4340	14-1490	100	Fluid Outlet Strainer
	Amspray	14068	14-2596	100	Fluid Outlet Strainer (solid end cap)
	Amspray	14069	14-2595	50	Fluid Outlet Strainer (solid end cap)
	Graco	167-024	14-184	30	Fluid Outlet Strainer (Long)
	Graco	167-025	14-185	60	Fluid Outlet Strainer (Long)
	Graco	167-026	14-186	100	Fluid Outlet Strainer (Long)
	Graco	167-027	14-187	200	Fluid Outlet Strainer (Long)
	Titan	730-067-30	14-2096	30	Fluid Outlet Strainer - for Epic 660ex, 690gx, Promark 690
	Titan	730-067	14-2097	60	Fluid Outlet Strainer - for Epic 660ex, 690gx, Promark 690
	Titan	730-067-10	14-2098	100	Fluid Outlet Strainer - for Epic 660ex, 690gx, Promark 690
	Titan	761-043	14-2101	60	Fluid Outlet Strainer - for all Elite Pumps
Wagner	508748	14-2747	60	Fluid Outlet Strainer - EPX / GPX	
	Graco	246-384	14-2675	60	Fluid Outlet Strainer, Short, Black
	Graco	246-382	14-2676	100	Fluid Outlet Strainer, Short, Blue
	Graco	243-080	14-2685	60	Fluid Outlet Strainer, Medium, Black
	Graco	243-081	14-2686	100	Fluid Outlet Strainer, Medium, Blue
	Graco	243-226	14-2687	200	Fluid Outlet Strainer, Medium, Red
	Graco	244-071	14-2694	30	Fluid Outlet Strainer, Long, Gray
	Graco	244-067	14-2695	60	Fluid Outlet Strainer, Long, Black
	Graco	244-068	14-2696	100	Fluid Outlet Strainer, Long, Blue
	Graco	244-069	14-2697	200	Fluid Outlet Strainer, Long, Red
	Graco	167-052	14-192	30	Fluid Outlet Strainer (Short)
	Graco	167-053	14-193	60	Fluid Outlet Strainer (Short)
	Graco	167-054	14-194	100	Fluid Outlet Strainer (Short)
	Graco	167-055	14-195	200	Fluid Outlet Strainer (Short)
	Graco	243-070	14-2650	30	Fluid Outlet Filter - for Magnum XR Pumps
	Speeflo	920-004	14-2265	50	Fluid Outlet Strainer
	Speeflo	920-005	14-2266	100	Fluid Outlet Strainer
	Speeflo	930-005	14-2344	5	Fluid Outlet Strainer with Check Ball
	Speeflo	930-006	14-2346	50	Fluid Outlet Strainer with Check Ball
	Speeflo	930-007	14-2347	100	Fluid Outlet Strainer with Check Ball
		Titan	500-200-03	14-2171	30
Titan		500-200-06	14-2172	60	Fluid Outlet Strainer, white (2-pack) - for Epic 440e, 447ex
Titan		500-200-10	14-2173	100	Fluid Outlet Strainer, yellow (2-pack) - for Epic 440e, 447ex
Titan		500-200-15	14-2174	150	Fluid Outlet Strainer, red (2-pack) - for Epic 440e, 447ex
	Binks	41-2627	14-345	100	Fluid Outlet Filter Screen (Long)
	Binks	41-2629	14-347	50	Fluid Outlet Filter Screen (Long)

BEDFORD® Replacement Parts

SPRAY GUN REPAIR PARTS

To order, contact your local
Paint Spray Equipment Dealer and ask for
Genuine Bedford Replacement Parts.

CONVENTIONAL & HVLP SPRAY GUN REPAIR PARTS

SPRAY GUN	REPLACES OEM PART NO.	BEDFORD PART NO.	DESCRIPTION
Binks Model 7	6-188	20-324	Repair Kit
Binks Model 18	6-189	20-328	Repair Kit
Binks Model 69	6-195	20-329	Repair Kit
Binks Model 95	54-3577	20-2154	Repair Kit
Binks Model 2001	6-229	20-1175	Repair Kit
Binks MACH I / BBR	54-3605	20-1880	Repair Kit
	54-3980	20-2340	Repair Kit (For Automatic Guns)
DeVilbiss JGA JGV JGK JGHV GFG LMG LMK MSA MSV PGA	KK-4987-2	20-2055	Repair Kit
DeVilbiss MBC	KK-4058-1	20-1146	Repair Kit
DeVilbiss JGHV (HVLP)	KK-4911	20-1596	Repair Kit
Kremlin MX / MR	129.659.901	20-2504	Repair Kit (Package of 3 seals each)
Sharpe 71 / 75PI	16000	20-1794	Repair Kit
Sharpe 775 PI	25196	20-1795	Repair Kit
Titan HVLP	770-389	20-2150	O-Ring Repair Kit



AIRLESS SPRAY GUN REPAIR PARTS

SPRAY GUN	REPLACES OEM PART NO.	BEDFORD PART NO.	DESCRIPTION
AIRLESSCO 007	120-011	58-2001	Valve Spring Unit Assembly
	120-035	58-2022	Valve Seat (Diffuser) Assembly
	120-037	58-2024	Ball & Holder Assembly
	KIT-2-007	20-2031	Minor Repair Kit - includes: Ball & Holder Assy, Valve Seat Assy, (2) Teflon Seals, (3) Tip Washers
	KIT-3-007	20-2032	Complete Repair Kit - includes: Ball & Holder Assy, Valve Seat Assy, Valve Spring Unit (complete), (3) Tip Washers
ASM 300 / 400	4402-G	58-2385	Diffuser with TC Seat (7/8 "G" Thread)
	4404	47-2227	Ball Mount & Valve Plunger Assembly
	4405	47-2229	Ball Mount with TC Ball
	4426-G	20-2392	Minor Kit - Diffuser ("G") & Ball Mount
	4427-G	20-2393	Gun Repair Kit - includes: Diffuser ("G"), Ball Mount & Valve Plunger Assy
	4428	47-2235	Valve Plunger Assembly
	4433-2	55-2721	Gun Filters - 50 Mesh (2-pack)
	4434-2	55-2722	Gun Filters - 100 Mesh (2-pack)
GRACO SILVER GUN: 208-327 208-663 208-664 220-954 GRACO FLEX GUN: 218-132 220-956	218-143	20-1401	Gun Repair Kit - Includes the following: (1) Fluid Needle & Ball Holder Assy (1) Diffuser Housing & Seat Assy (1) Tip Washer (1) Diffuser Gasket

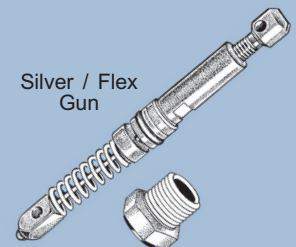
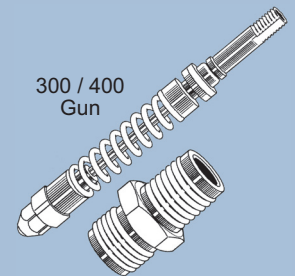
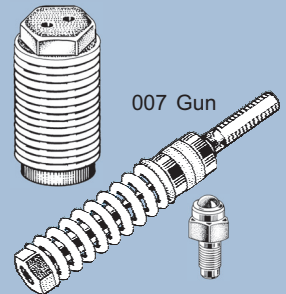

To order, contact your local
Paint Spray Equipment Dealer and ask for
Genuine Bedford Replacement Parts.

BEDFORD® Replacement Parts

SPRAY GUN REPAIR PARTS

AIRLESS SPRAY GUN REPAIR PARTS (Continued)

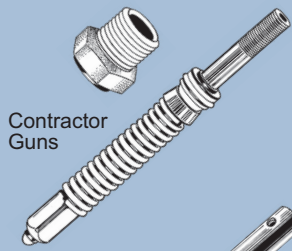

Contractor Guns

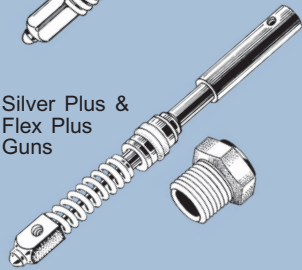

Silver Plus & Flex Plus Guns

Contractor II and FTx-II Guns

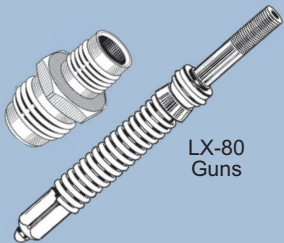
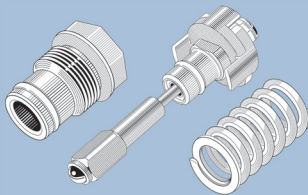

LX-80 Guns

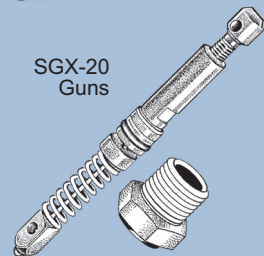

SGX-20 Guns



G-10 Gun

SPRAY GUN	REPLACES OEM PART NO.	BEDFORD PART NO.	DESCRIPTION
GRACO CONTRACTOR: 217-593 220-955 235-990 243-282 820-165 824-950 CONTRACTOR FTx: 238-350 239-045 239-516 243-285 243-374 243-375 824-004 CONTRACTOR ST: 238-352 SG3: 243-238 243-382	218-021	47-2062	Swivel Assembly for Gun Handle
	218-070	20-1502	Gun Repair Kit - Includes the following: (1) Fluid Needle & Ball Holder Assembly (1) Diffuser Assembly (1) Tip Washer, (1) Locknut, (1) Diffuser Gasket
	218-131	14-1484	Fluid Filter Assembly (50 Mesh)
	218-133	14-1485	Fluid Filter Assembly (100 Mesh)
GRACO SILVER +PLUS+ GUN: 235-460 thru 235-464 236-531 237-695 238-591 238-941 238-966 243-283 246-240 FLEX +PLUS+ GUN: 235-457 235-458 235-459 237-691 243-284 246-468	235-474	20-1930	Gun Repair Kit - Includes the following: (1) Fluid Needle Assembly (1) Diffuser Seat Assembly (1) Tip Washer (1) Diffuser Gasket
	287-031	20-2701	Gun Repair Kit - Includes the following: Diffuser Seat Assy & O-Ring, Needle Assy, Return Spring
GRACO CONTRACTOR II: 246-220 246-221 246-222 246-224 246-225 246-434 246-538 824-987 CONTRACTOR FTx-II: 246-230 thru 246-235 246-435 246-539 246-540	287-032	14-2664	Gun Filter, 60 Mesh, Medium, Black
	287-033	14-2665	Gun Filter, 100 Mesh, Fine, Blue
	TITAN LX-80 GUN	500-200-03	14-2171
500-200-06		14-2172	Gun Filter, 60 Mesh, Medium, White (2-pack)
500-200-10		14-2173	Gun Filter, 100 Mesh, Fine, Yellow (2-pack)
500-200-15		14-2174	Gun Filter, 150 Mesh, Extra-Fine, Red (2-pk)
TITAN SGX-20 GUN	580-034	20-2095	Gun Repair Kit - Includes the following: Needle Assy, Diffuser Seat Assembly, Diffuser Gasket, Locknut
	520-025	20-2088	Gun Repair Kit - Includes the following: Needle Assy, Diffuser Seat Assembly, Diffuser Gasket
WAGNER "G-10" SPRAY GUNS: G-9 / G-9N G-10 / G-10N Parts are also compatible with Amspray EZ-3000 & Larius AT-250 spray guns.	34377	14-832	Filter, Medium (White, 50 Mesh)
	34383	14-834	Filter, Extra-Fine (Red, 180 Mesh)
	43225	58-1495	11/16" Diffuser Housing & Seat Assembly
	89323	14-831	Filter, Coarse (Green, 30 Mesh)
	89324	14-833	Filter, Fine (Yellow, 100 Mesh)
	149342	58-2016	7/8" Diffuser - G10 with Graco "G" Thread
	149700	58-2305	Needle Assembly
	270957	20-1751	Gun Repair Kit - Includes the following: Valve Spring Unit & Ball Holder Assembly, 11/16" Diffuser Assy, X-Fine Filter, Med Filter, Spring, (2) Swivel Washers, (2) Tip Washers, (2) Handle Washers, Locknut
	279625	20-2300	Gun Repair Kit - Includes the following: Valve Spring Unit & Ball Holder Assembly, 7/8" Diffuser Housing & Seat Assembly, Spring, Locknut, Swivel Washer, Tip Washer, Upper Handle Washer
	279919	20-2160	Gun Repair Kit - Includes the following: Valve Spring Unit & Ball Holder Assembly, 7/8" Diffuser Housing & Seat Assembly, Spring, Locknut, Swivel Washer, Tip Washer, Upper Handle Washer
347706	47-2450	Gun Handle Swivel Assembly & Washer	
WAGNER G-10XL and G-12XL	296261	58-2735	Diffuser Seat Assembly
	296294	20-2737	Gun Repair Kit - Includes the following: Needle Assy, Diffuser Seat Assembly, Locknut

AIR PRESSURE REGULATORS

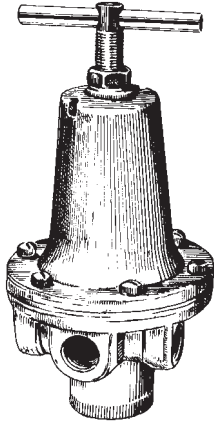

HEAVY DUTY SERIES

Ideal for high capacity continuous service. Relieving type regulators are available in sizes from 1/4" to 1", all sizes have two 1/4" gauge ports.

SPECIFICATIONS

Maximum Initial Pressure 300 PSI
Output Pressure Range 0-125 PSI
Operating Temperature Range 40°-120°F

SIZE	MAX SCFM	BEDFORD PART NO.
1/4"	60	26-712
3/8"	90	26-713
1/2"	200	26-714
3/4"	380	26-716
1"	380	26-718

TYPICAL PERFORMANCE FLOW CURVES

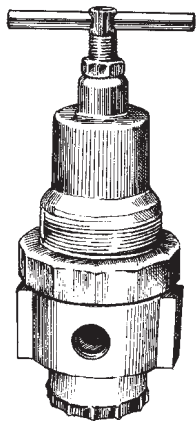
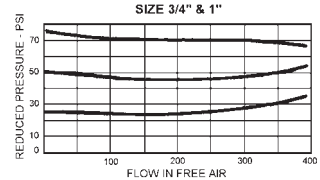
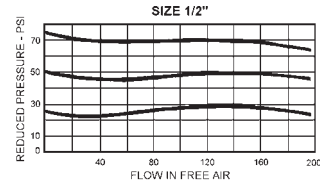
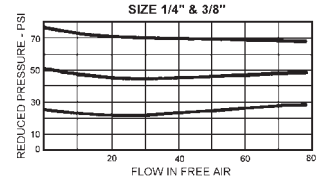

GENERAL PURPOSE SERIES

STANDARD MODEL

With same operating pressure and temperature range as the heavy duty series, this regulator is an economical unit where flow requirements do not exceed 80 SCFM.

1/4" inlet and outlet with two regulated 1/4" gauge ports.

REPLACES DEVILBISS PART NO.	BEDFORD PART NO.
HAR-505	26-1125

SERIES INSTALLATION MODELS

P/N 26-1119 has 3/8" inlet, two 1/4" unregulated ports, and 1/2" regulated outlet.

P/N 26-2328 has 1/4" inlet, 1/4" unregulated port, and two 1/4" regulated outlets.

Specifications same as standard model.

REPLACES DEVILBISS PART NO.	BEDFORD PART NO.
HAR-502	26-2328
HAR-555	26-1119

GAUGES

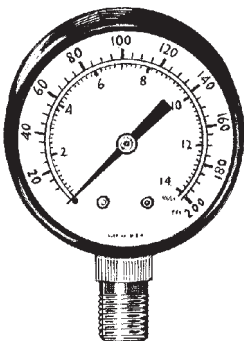

CONNECTION (MALE)	MOUNT	PRESSURE RANGE (PSI)	DIAL DIAMETER	BEDFORD PART NO.
1/8" NPT	BOTTOM	0-60	1-1/2"	28-1358
1/8" NPT	REAR	0-160	1-1/2"	28-706
1/4" NPT	BOTTOM	0-60	2"	28-721
1/4" NPT	BOTTOM	0-100	2"	28-759
1/4" NPT	BOTTOM	0-160	2"	28-766
1/4" NPT	REAR	0-160	2"	28-705
1/4" NPT	BOTTOM	0-160	2-1/2"	28-875
1/4" NPT	BOTTOM	0-200	2"	28-719
1/4" NPT	REAR	0-300	2"	28-704

All gauges have glass face & black finished metal case.

To order, contact your local
Paint Spray Equipment Dealer and ask for
Genuine Bedford Replacement Parts.

BEDFORD® Replacement Parts AIR CONTROL COMPONENTS

FILTERS

Two stage filtration effectively removes airline scale, dirt and moisture. Available in three models listed below with 40 Micron filter element, sizes from 1/4" to 1".

UNIT WITH TRANSPARENT BOWL & GUARD			
SIZE	PART NO.	MAX SCFM	BOWL SIZE
1/4"	25-3722	55	5 oz.
3/8"	25-3723	75	5 oz.
1/2"	25-3724	100	5 oz.

UNIT WITH METAL BOWL & SIGHT GLASS			
SIZE	PART NO.	MAX SCFM	BOWL SIZE
1/2"	25-3744	100	5 oz.
3/4"	25-726	250	16 oz.
1"	25-728	350	16 oz.

UNIT WITH OVERSIZED METAL BOWL			
SIZE	PART NO.	MAX SCFM	BOWL SIZE
3/4"	25-746	250	32 oz.
1"	25-748	350	32 oz.

SPECIFICATIONS

Maximum Supply Pressure	(PSI)
Transparent Bowl	150
Metal Bowl w/ Sight Glass	250
Oversized Metal Bowl	300

Operating Temperature	(°F)
Transparent Bowl	40°-120°
Metal Bowl w/ Sight Glass	40°-150°
Oversized Metal Bowl	40°-180°

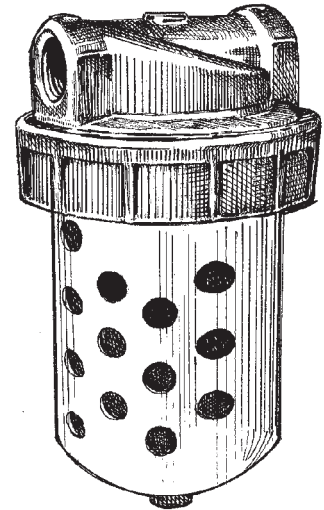

LUBRICATORS

Dial set adjustment and full view drip tube for simple operation. Unit may be filled while pressurized without shutting down equipment. Available in three models listed below, sizes from 1/4" to 1".

UNIT WITH TRANSPARENT BOWL & GUARD			
SIZE	PART NO.	MAX SCFM	BOWL SIZE
1/4"	27-3732	40	5 oz.
3/8"	27-3733	70	5 oz.
1/2"	27-3734	112	5 oz.

UNIT WITH METAL BOWL & SIGHT GLASS			
SIZE	PART NO.	MAX SCFM	BOWL SIZE
3/4"	27-736	290	16 oz.
1"	27-738	320	16 oz.

UNIT WITH OVERSIZED METAL BOWL			
SIZE	PART NO.	MAX SCFM	BOWL SIZE
3/4"	27-756	290	32 oz.
1"	27-758	320	32 oz.

SPECIFICATIONS

Maximum Supply Pressure	(PSI)
Transparent Bowl	150
Metal Bowl w/ Sight Glass	250
Oversized Metal Bowl	300

Operating Temperature	(°F)
Transparent Bowl	40°-120°
Metal Bowl w/ Sight Glass	40°-150°
Oversized Metal Bowl	40°-180°

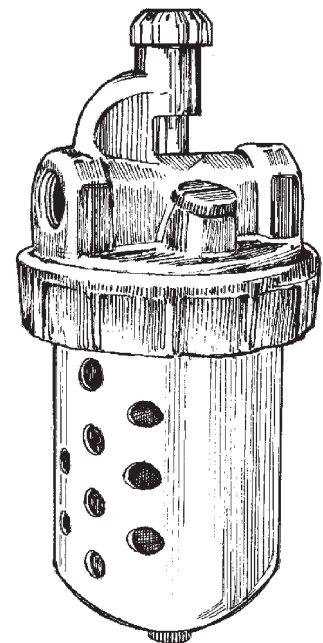

MINIATURE SERIES

These components are specifically designed for applications where a small economical unit is required. Especially useful on air tools, cylinders, valves, paint sprayers, and pressurized tanks.

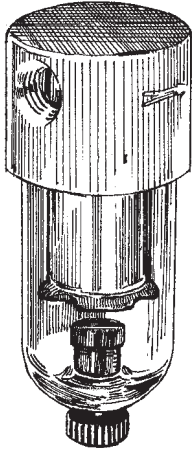

MINI FILTER

Two stage filtration removes airline scale, dirt and moisture. Has 20 Micron filter element, aluminum body, and shatterproof clear polycarbonate bowl. Connections are 1/4" and the bowl capacity is 1 oz.

SPECIFICATIONS

Flow 22.0 SCFM
Maximum Supply Pressure 150 PSI
Operating Temperature 40°-120° F
Height: 4" Dia: 1-9/16" Weight: 1/4 lb

PART NO.

25-720

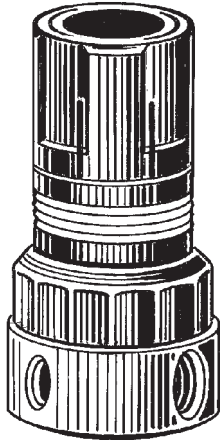
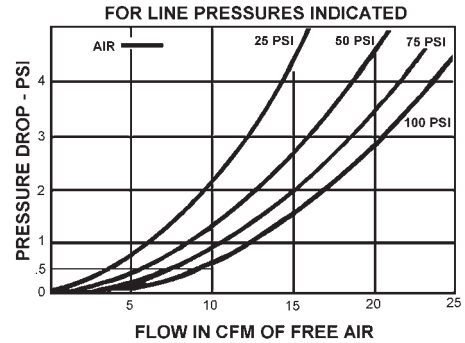

MINI REGULATOR

Relieving type regulator has aluminum body and acetyl spring cage and adjusting knob. 1/4" inlet and outlet ports with two 1/8" gauge ports for use with P/N 28-706 & 28-1358 gauges.

SPECIFICATIONS

Flow 16.0 SCFM
Maximum Supply Pressure 300 PSI
Output Pressure Range 0-125 PSI
Operating Temperature 40°-120° F
Height: 3" Dia: 1-9/16" Weight: 1/4 lb

PART NO.

26-710

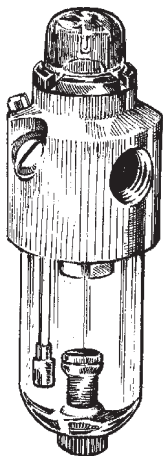
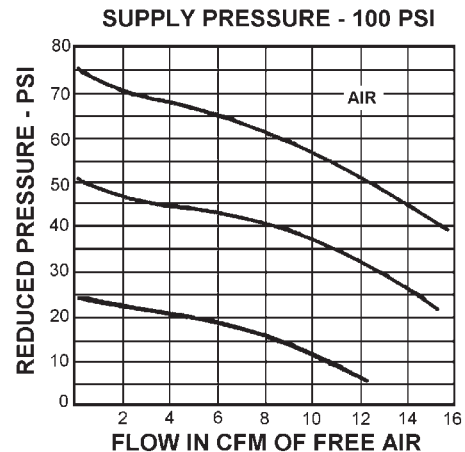

MINI LUBRICATOR

Unit has rugged aluminum body and shatterproof clear polycarbonate bowl and two large fill ports for quick filling. Connections are 1/4". 1 oz. bowl capacity.

SPECIFICATIONS

Flow 12.0 SCFM
Maximum Supply Pressure 150 PSI
Operating Temperature 40°-120° F
Height: 4-7/16" Dia: 1-9/16" Weight: 1/4 lb

PART NO.

27-730

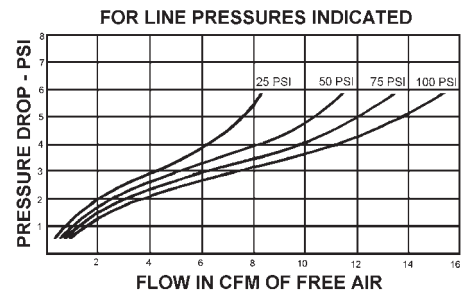

To order, contact your local
Paint Spray Equipment Dealer and ask for
Genuine Bedford Replacement Parts.

BEDFORD® Replacement Parts

AIR CONTROL COMPONENTS

AIR RELIEF SAFETY VALVE

Air relief safety valves have all brass body construction with stainless steel ball, forming metal to metal valve seal assuring reliable performance and long life. 1/4" NPT male connection. Maximum temperature 300° F. ASME Approved.

DESCRIPTION	RELIEF PRESSURE (PSI)	BEDFORD PART NO.
Air Relief Safety Valve	80	29-1676
	110	29-941



AIR CONTROL COMPONENT REPLACEMENT PARTS

REGULATOR REPAIR PARTS

DESCRIPTION	FOR UNIT NO.	BEDFORD PART NO.
Repair Kit	26-1119, 26-1125, 26-2328	24-1126
Repair Kit	26-712 & 26-713	24-725
Repair Kit	26-714	24-727
Repair Kit	26-716 & 26-718	24-731
Cage & Knob	26-710	24-1023
T-Handle & Cage	26-1119, 26-1125, 26-2328	24-1024
T-Handle	26-712 & 26-713	24-1020
T-Handle	26-714	24-1021
T-Handle	26-716 & 26-718	24-1022

FILTER REPLACEMENT ELEMENTS

DESCRIPTION	FOR UNIT NO.	BEDFORD PART NO.
40 Micro Element	25-37XX Filters	24-3760

MOUNTING BRACKETS

DESCRIPTION	FOR UNIT NO.	BEDFORD PART NO.
Bracket & Nut	Mini-Regulator	24-1968
Nut Only	Mini-Regulator	24-1972
Bracket & Nut	26-1125, 26-1119, 26-2328	24-1969
Nut Only	26-1125, 26-1119, 26-2328	24-1973
Bracket	26-712 & 26-713	24-1970
Bracket	26-714	24-1971

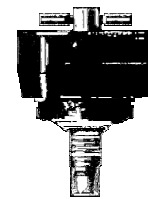

AUTO-DRAIN CONVERSION

For Field conversion of Standard Manual Drain to Automatic Drain Operation

For Models: 25-722, 25-723, 25-724, 25-726, 25-728, 25-744, 25-746, 25-748

Part No. 24-729

For Models: 25-3722, 25-3723, 25-3724, 25-3744

Part No. 24-3729

Chemical Resistance of Materials – Fluid Compatibility Data

Type of Fluid	NY	TE	VI	LE
Acetate Solvents	1	1	0	0
Acetic Acid	3	1	3	3
Acetone	1	1	3	2
Acetylene	1	1	1	1
Air	1	0	0	0
Air (Hot)	1	0	0	0
Alcohols	2	1	1	1
Ammonia (Anhydrous) Liquid	3	1	3	3
Ammonia (Gas)	2	0	0	0
Ammonium Hydroxide	2	1	1	2
Ammonium Chloride	3	1	1	0
Aniline	3	1	2	0
Aliphatic Hydrocarbons	1	0	0	0
Aromatic Hydrocarbons	1	0	0	0
Auto Transmission Fluid	1	0	0	0
Barium Chloride	3	1	1	1
Barium Sulphide	2	1	1	1
Benzine (Benzol)	1	1	3	2
Boric Acid	2	1	1	1
Bromine	3	1	1	3
Butane	1	1	1	2
Butyl Alcohol (Butanol)	2	1	0	0
Butyl Acetate	1	1	3	2
Calcium Chloride	2	1	1	1
Carbolic Acid	3	1	1	3
Carbonic Acid	2	1	1	1
Chlorine (Wet)	3	1	0	0
Chloro Methane (Methylene Chloride)	2	1	1	0

Type of Fluid	NY	TE	VI	LE
Citric Acid	2	1	1	0
Cresol	3	1	1	3
Diesel Fuel	1	1	1	1
Ethanol	2	1	1	2
Ethers	1	1	3	2
Ethyl Acetate	1	1	3	2
Ethylene Glycol ◆	2	1	1	0
Formaldehyde	2	1	1	3
Gasoline	1	1	1	1
Hydraulic Fluid (Petroleum Based)	1	1	1	1
Hydraulic Fluid ◆ (Phosphate Ester)	2	1	1	2
Hydraulic Fluids ◆ (Water/Glycol)	2	1	0	0
Hydrochloric Acid	3	1	1	2
Hydrogen Peroxide	3	1	1	1
Isopropyl Alcohol	2	1	1	2
Isocyanates ■	3	0	0	0
Kerosene	1	1	1	1
Ketones	1	1	3	2
Lacquers & Solvents	1	1	3	2
Linseed Oil	1	1	1	1
Lubricating Oils (Petroleum Base)	1	1	1	1
Lubricating Oils (Diester Base)	1	0	0	0
Mercury	1	1	1	1
Mercuric Chloride	2	1	1	0
Methanol	2	1	1	2
Methyl Ethyl Ketone (MEK)	1	1	3	2
Methylene Chloride	2	1	1	0
Mineral Oil	1	1	1	1

Type of Fluid	NY	TE	VI	LE
Naphtha	1	1	1	1
Natural Gas	1	1	0	0
Nitric Acid (70%)	3	3	0	0
Oleic Acid	2	1	1	1
Oxalic Acid	2	1	1	2
Oxygen	2	3	0	0
Paint (Oil / Alkyn Based)	1	1	2	1
Paint (Water Based) ◆	1	1	1	1
Phenol	3	1	2	3
Potassium Salt Solutions	2	1	0	0
Refrigerant 12	1	0	0	0
Refrigerant 22	1	0	0	0
Refrigerant 502	1	0	0	0
Sodium Chloride Solution	2	1	1	1
Sodium Hydroxide (<20%)	2	1	1	3
Sodium Hypochlorite Solution	3	1	1	0
Steam	3	0	0	0
Sulphuric Acid	3	1	1	3
Trichlorethylene	2	1	0	0
Toluene (Toluol)	1	1	2	2
Turpentine	1	1	1	2
Varnishes & Solvents	1	1	0	2
Water, Fresh (Cold)	1	1	1	1
Water, Salt (Cold)	2	1	1	1
Water, Fresh (Hot over 66°C)	3	1	1	3
Water, Salt (Hot over 66°C)	3	1	1	3
Xylene	1	1	3	2
Zinc Chloride Solutions	3	1	1	1

MATERIAL CODE: NY - Nylon TE - Teflon VI - Viton LE - Leather

RESISTANCE CODE: 1 - Little or no effect 2 - Minor or moderate effect 3 - Severe Effect 0 - Not tested

◆ Recommended operating temperature not to exceed 160°F

■ Precautions must be taken to keep moisture from permeating hose

*The information given is based on research and experience and to the best of our knowledge is reliable.
However, we must emphasize that the chart should be used as a guide only.*

Pipe Thread Sizing Guide

To size a **Male NPT or NPS thread**, determine which of the guide circles below best represents the thread's **outside diameter**.



To size a **Female NPT or NPS thread**, determine which of the guide circles below best represents the thread's **inside diameter**.

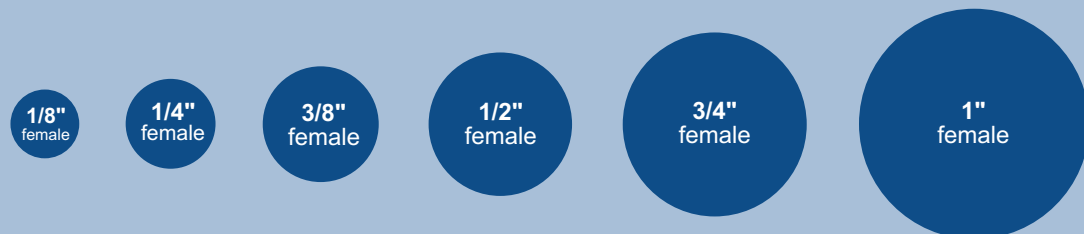

To order, contact your local
Paint Spray Equipment Dealer and ask for
Genuine Bedford Replacement Parts.

BEDFORD® Replacement Parts Index

ITEM	PAGE
ADAPTERS	
Low Pressure	69, 70
Swivel Unions, High Pressure	69
AIR CONTROL COMPONENTS	
Filters, Air Line	77
Lubricators, Air Line	77
Miniature Series	78
Regulators, Air Line	76
AIRLESSCO	
Glidden Pumps, Quick Reference	43
Replacement Parts for	3-4
Spray Guns, Quick Reference	74
AMSPRAY	
Glidden Pumps, Quick Reference	43
Pump Components, Quick Reference	44
Replacement Parts for	43-47
ASM	14-38, 74
BINKS	
Pump Components, Quick Reference	5
Replacement Parts for	5-11
Spray Guns, Quick Reference	5, 74
CLOTHING, Disposable, Protective	62
CONNECTORS, LP Hose, reuseable	66
COUPLINGS	
Hose	66
Quick Disconnect	67, 69
CUP ASSEMBLY, Quart Siphon	60
DEVILBISS	
Replacement Parts for	12-13
Spray Guns, Quick Reference	74
FILTERS	
Airless Gun	71
Air Line	77-78
Air Line, Miniature	78
Inlet Strainers	72
Inline, Fluid	71
Manifold	73
Tip	71
FITTINGS, Hose	66-67, 69-70
FULLER O'BRIEN, Pump Interchange	44
GASKETS, Cup and Tank Lid	63
GAUGES	76
GLIDDEN	
Airlessco Private Label, Pump Kits	43
Amspray Private Label, Pump Components	43-44
Wagner Private Label, Pump Kits	43
GRACO	
Replacement Parts for	14-38
Spray Guns, Quick Reference	74-75
GUN, Spray, Repair Parts	74-75
H.E.R.O.	
Pump Components, Quick Reference	39
Replacement Parts for	39-41
HOSE	
Air & Fluid, Low Pressure	66-67
Airless Spray	68
Pressure Washer	67
INTERNATIONAL PUMP MANUFACTURING (IPM)	60
KREMLIN	42
LARIUS	42
LUBRICATORS	
Air Line	77
Air Line, Miniature	78
M.A.B., Pump Interchange	44
NIPPLES	70
PLUGS	70
PRESSURE WASHER HOSE	67

ITEM	PAGE
QUICK DISCONNECTS	67, 69
QUICK REFERENCES	
Airlessco Private Label Pump Kits	43
Airlessco Spray Guns	74
Amspray Pump Components	43-44
ASM Spray Guns	74
Binks Pump Components	5
Binks Spray Guns	5, 74
Devilbiss Spray Guns	74
Glidden Pumps, Private Labeled by Amspray	43-44
Glidden Pumps, Private Labeled by Wagner	43
Glidden Pumps, Private Labeled by Airlessco	43
Graco Spray Guns	74-75
H.E.R.O. Pump Components	39
Sharpe Spray Guns	74
Titan Spray Guns	75
Wagner Spray Guns	75
REGULATORS	
Air Pressure	76
Air Pressure, Miniature	78
REPLACEMENT PARTS FOR...	
Airlessco	3-4
Amspray	43-47
ASM	14-38, 74
Binks	5-11
Devilbiss	12-13
Glidden, Private Label Pumps	43-47
Graco	14-38
H.E.R.O.	39-41
Internation Pump Manufacturing (IPM)	60
Kremlin	42
Larius	42
Sharpe	41
Speeflo	45-59
Titan	45-59
Wagner	45-59
REVERSIBLE AIRLESS SPRAY TIPS.	61
SHARPE	
Replacement Parts for	41
Spray Guns, Quick Reference	74
SPEEFLO	
Replacement Parts for	45-59
SPRAY GUN REPAIR KIT REFERENCES	
Airlessco	74
Binks	5, 74
Devilbiss	74
Graco	74-75
Sharpe	74
Titan	75
Wagner	75
STRAINER BAGS, Paint	62
STRAINERS, Inlet.	72
TITAN	
Replacement Parts for	45-59
Spray Gun Kits, Quick Reference	74-75
VALVES	
Air Metering, "Cheater"	65
Air Relief, Safety	79
Ball Valves	64-65
Dump Valves, High Pressure	64
WAGNER	
Amspray Pump Components, Quick Reference	43-44
Spray Guns, Quick Reference	74-75
Replacement Parts for	43-59

Your local Bedford dealer is:

ORDER
FORM



PAGE 2

PARTS
FOR

AIRLESSCO

EQUIPMENT

PAGES 3-4

PARTS
FOR

BINKS

EQUIPMENT

PAGES 5-11

PARTS
FOR

DEVILBISS

EQUIPMENT

PAGES 12-13

PARTS
FOR

GLIDDEN

EQUIPMENT

PAGE 43

PARTS
FOR

**GRACO /
ASM**

EQUIPMENT

PAGES 14-38

PARTS
FOR

H.E.R.O.

EQUIPMENT

PAGES 39-41

PARTS
FOR

**INT'L PUMP
MFG (IPM)**

EQUIPMENT

PAGES 60

PARTS
FOR

KREMLIN

EQUIPMENT

PAGE 42

PARTS
FOR

LARIUS

EQUIPMENT

PAGE 42

PARTS
FOR

SHARPE

EQUIPMENT

PAGE 41

PARTS
FOR

**TITAN /
SPEEFLO**

EQUIPMENT

PAGES 45-59

PARTS
FOR

**WAGNER /
AMSPRAY**

EQUIPMENT

PAGES 45-59

REVERSIBLE
AIRLESS SPRAY
TIPS



PAGE 61

PAINT STRAINERS



PAGE 62

DISPOSABLE
CLOTHING



PAGE 62

TANK & CUP
LID GASKETS

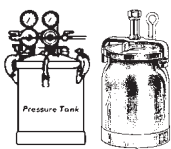

PAGE 60, 63

VALVES

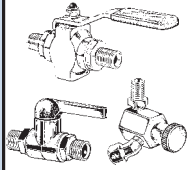

PAGES 64-65

HOSE &
ASSEMBLIES

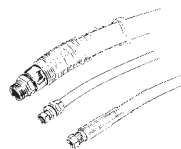

PAGES 66-68

FITTINGS &
ADAPTERS

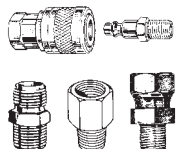

PAGES 69-70

FILTERS &
STRAINERS



PAGES 71-73

SPRAY GUN
REPAIR PARTS



PAGES 74-75

**To order, contact your local
Paint Spray Equipment Dealer
and ask for Genuine
Bedford Replacement Parts.**

GAUGES

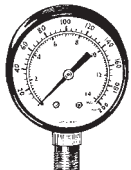

PAGE 76

AIR CONTROL
COMPONENTS

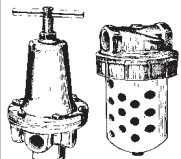

PAGES 76-79

RELIEF VALVES



PAGE 79